

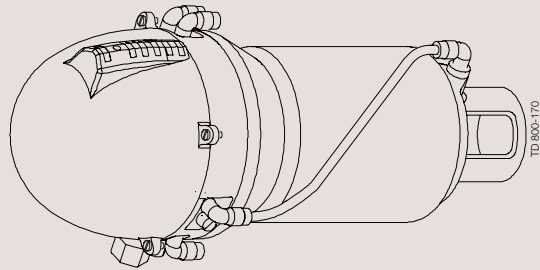

Installation Instruction

ThinkTop® for series 700 valves Digital 8-30 VDC PNP/NPN



TD 800-170

IM70851EN3
9611-99-4175

2009-03

Alfa Laval Kolding A/S, www.alfalaval.com

Installation on air actuators:

1.

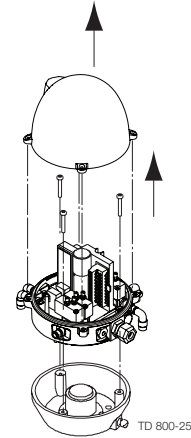

1. Remove the cover by loosening the four cross recess screws.
2. Separate the adapter from the base by loosening the three recess screws on top of the base.

2.

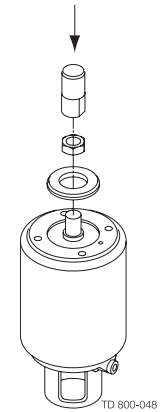

1. Fit air fittings on actuator.
2. Position packing retainer in recess on actuator top.
3. Fit counter nut and indicator (magnet) on actuator rod. Engage approx. 1/4" thread. Tighten counter nut and indicator with two wrenches.

3.

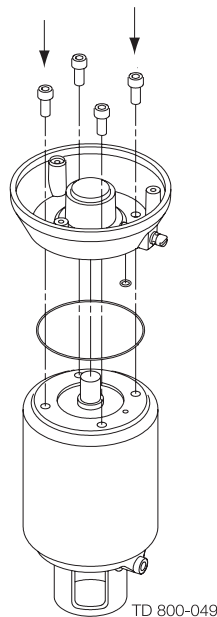

1. Place the two O-rings in the grooves in the bottom of the adapter. Then place the adapter on the actuator top. The small O-ring must be positioned over the air hole on the actuator.
2. Fasten the adapter with the four 5/16" Allen screws.

4.

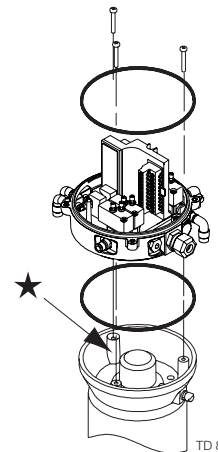

Mount the base on the adapter in the position needed (can be rotated 120° in both directions). Note that one of the screw towers on the adapter has a guide recess (see ★ on drawing).

5.

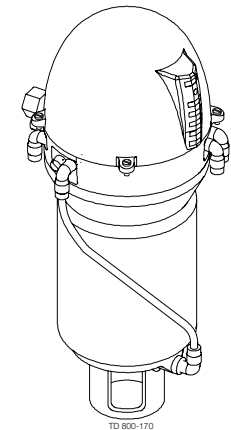

Fit 1/4" air hose to ThinkTop and actuator (see drawing "Air Connections" (point 8 next page)).

6.

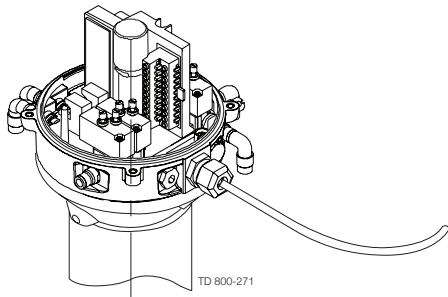

1. Install cable (if not pre-installed) through the cable gland (see drawing "Electrical connection, internal" (below)).
2. Tighten cable gland.

7.

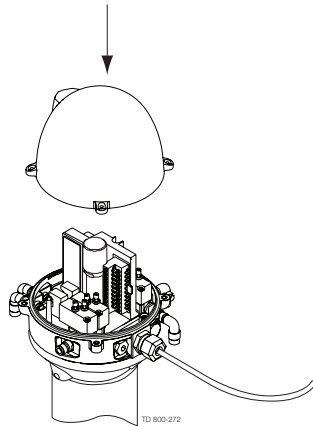

1. Perform set up routine.
2. Mount the cover.

Note! The IR keypad may be used to set up the unit. To energize the valve, use separate air supply or be in radio contact with the control room.

Air connections:

8.

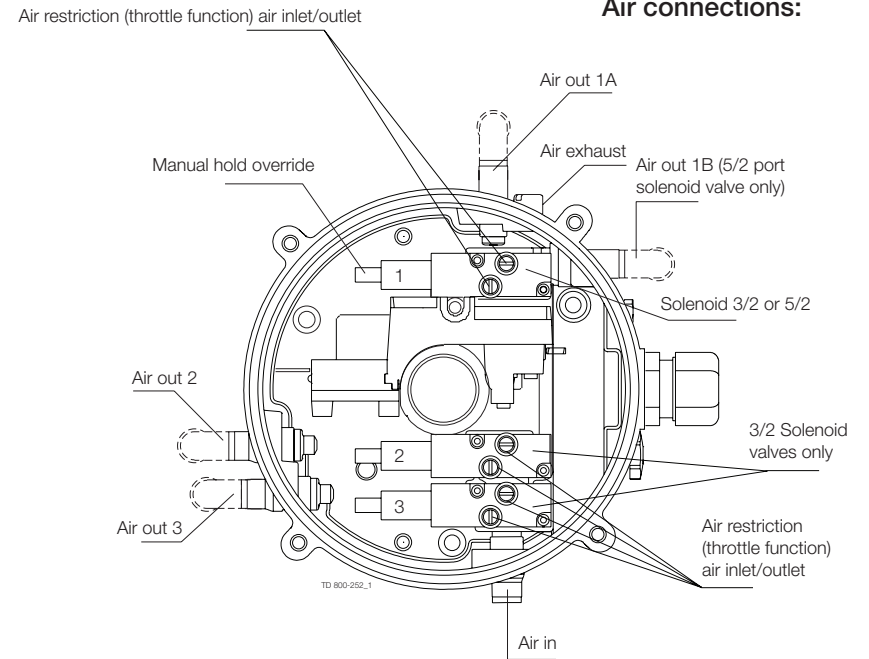

Electrical connection, internal:

9.

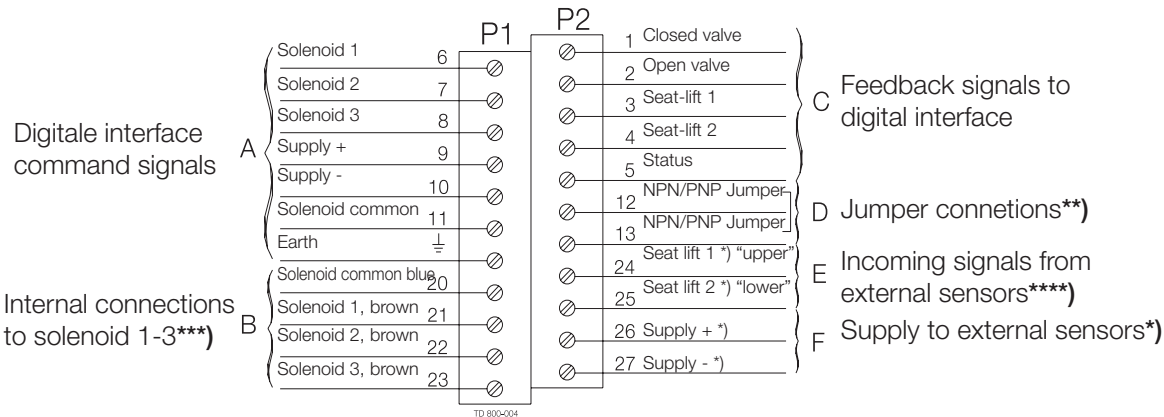

- *) **Note!**
Terminals 24, 25, 26 and 27 can be used for external seat-lift sensors as well as for any digital input. Always use an external PNP sensor. Two external signals can be connected, they are associated with feedback signal 3 (seat-lift 1) and 4 (seat-lift 2). External sensor must always be a 8-30 VDC PNP 3 wire sensor. Connect (-) common on terminal 27, and (+) common on terminal 26. The signals from the external sensors are associated as follows: sensor signal on terminal 24 (seat-lift 1) associated with feedback 3 (seat-lift 1), and sensor signal on terminal 25 (seat-lift 2) associated with feedback 4 (seat-lift 2).
- ***) **Note!**
Jumper present = PNP. If changing the function a power recycle is necessary. The selection NPN/PNP is done by the jumper.
- ****) **Note!**
Internal connections: Terminals for connection for the solenoids mounted internally in the control head. The number of solenoids actually mounted in the control head could be 0 - 3. The signals are taken directly from the terminal row.
- *****) **Note!**
If using external sensor, the sensor must be active/activated when performing a set-up routine of the control head.

Note! Remember to isolate wires that are not in use.

Very Important!
Please read detailed instructions in instruction manual ESE00353.