



Instruction Manual

Unique PMO Plus[®] Series Sanitary Mixproof Valve
sizes 1½", 2", 2½", 3", 4" and 6"

Effective 11/1/07
Revised 1/1/09
Revised 8/1/09



Unique PMO Plus[®]
Mix-Proof Valve



Unique PMO Plus[®]-CP
Mix-Proof Valve

EPM00041ENUS 1107

The information contained herein is correct at the time of issue but may be subject to change without prior notice.

Introduction	4
Safety	5
Installation	6
Specifications	8
Pneumatic Connections.....	10
Position Indication	11
Electrical Connections	12-1 thru 12-4
ThinkTop.....	13
Cleaning Procedures	32
Valve Seat Position Indication	36
Maintenance.....	41
Parts List	61

Thank you for purchasing an Alfa Laval product.

This manual has been provided to instruct you how to operate and service this product correctly and safely. Be sure to follow all directions and instructions; failure to do so could result in personal injury or equipment damage.

This manual should be considered part of this product and should remain with it at all times for reference. (If you sell it, please be sure to include this manual with it).

Warranty is provided as part of Alfa Laval's commitment to our customers who operate and maintain their equipment as this manual dictates. Failure to do so may result in loss of warranty.

Where defects appear on the product during the warranty period, Alfa Laval Inc. will back the product and correct the problem. Should the equipment be modified or not kept in the manner prescribed within this manual, the warranty will become null and void.

Follow Safety Directions

Read this manual thoroughly before working on equipment.

Leave all safety stickers on equipment and keep them maintained in legible condition. In the event that stickers become damaged or are missing, contact Alfa Laval for replacement.

Maintain equipment in good working condition.

Do Not Make Machine Modifications

Alfa Laval offers a full range of products to suit all your needs. Therefore, product modification is never necessary.

Keep Maintenance Safe

Replace damaged or worn parts immediately. Never allow old product, debris, or any lubricants to build up on equipment. Never operate unless equipment is in proper working order.

Before attempting to service the machine, disconnect all power and compressed air. Allow machine to come to a complete stop. Never service a machine while it is operating. Keep all limbs away from moving equipment. Be sure that product pressure has been relieved before beginning maintenance.

Unpacking

The valves should be unpacked immediately upon receipt from the factory and carefully inspected for damage that may be occurred during shipping. The equipment should also be checked against the bill of lading to make sure there are no shortages. Any damage or shortage should be reported to the carrier.

Locating

The valves are mounted directly into the product line. Care should be taken, however, to locate the valves in a place where they are easily reached for maintenance and disassembly.

Installing

Line Mounted Valve: The valves may be installed in lines that are firmly supported and capable of carrying the valve's weight. Mount valves vertically, or as close to vertical as possible.

Clearances required for removal of actuator/plug assembly for repair.

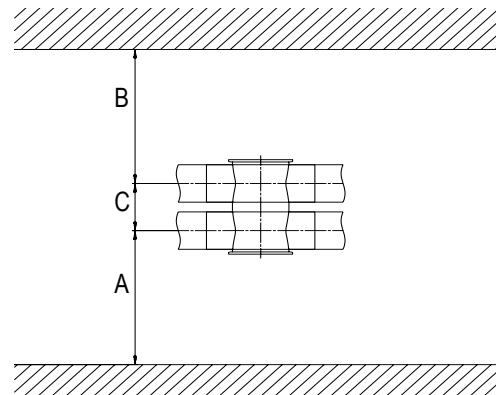

Unique *PMO Plus*® Series

	1½"	2"	2½"	3"	4"	6"
A	3.35"	8¼"	10½"	10½"	12¾"	8.66"
C	2.39"	3.02"	3.52"	4.02"	5.02"	6.8"
*B	29.6"	41¾"	48½"	48½"	52¾"	29.6"

*Includes *ThinkTop*®

It is important to observe the specification data during installation, operation and maintenance.

Max. Process Pressure

145 PSI — All Sizes

Max. Air Pressure

116 PSI — All Sizes

Min. Process Pressure

Full Vacuum

Temperature Range

23°F to 257°F

Materials

Product wetted steel parts: Acid-resistant steel AISI 316L

Other steel parts: Stainless steel AISI 304/304L

Product wetted parts: NBR, HNBR, EPDM or FPM

Other Seals: CIP Seals: EPDM
Actuator seals: NBR

Finish: int./ext. Polished Ra<32

Note: The Ra-values are only for the internal surfaces.

CIP solution flows for seat lift

(viscosity and density similar to water)

	CV Values					
	Unique PMO Plus®					
	1½"	2"	2½"	3"	4"	6"
Upper seat lift	1.7	2.6	3.9	3.9	5.3	12.1
Lower seat push	1.0	2.2	3.6	3.6	4.9	10.2

The following formula is used to estimate CIP flow during seat lifts:

$$Q = Cv (\sqrt{\Delta p})$$

Where: Q = Flow in USGPM

Cv = Value from table above

* Δ p = CIP pressure in PSI

CIP solution flows for seat lift

(viscosity and density similar to water)

	CV Values					
	Unique PMO Plus®-CP					
	1½"	2"	2½"	3"	4"	6"
Upper seat lift	1.7	2.6	3.9	3.9	5.3	12.1
Lower seat push	2.3	4.5	5.9	5.9	7.5	13.9

The following formula is used to estimate CIP flow during seat lifts:

$$Q = Cv (\sqrt{\Delta p})$$

Where: Q = Flow in USGPM

Cv = Value from table above

* Δ p = CIP pressure in PSI

Valve Pneumatic Functions:
 Unique **PMO Plus**® Series

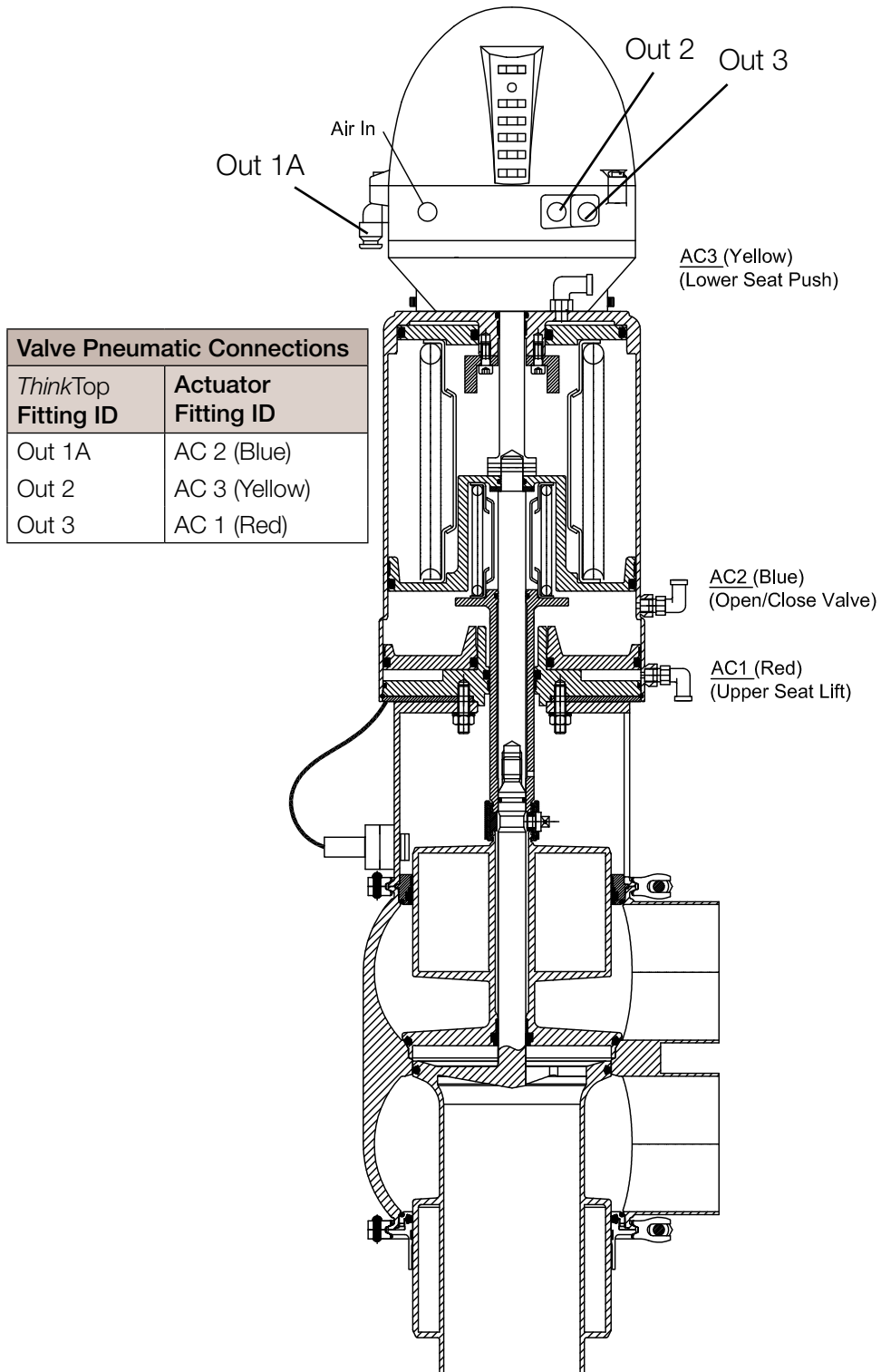

Valve Position Indication:
Unique **PMO Plus**® Series

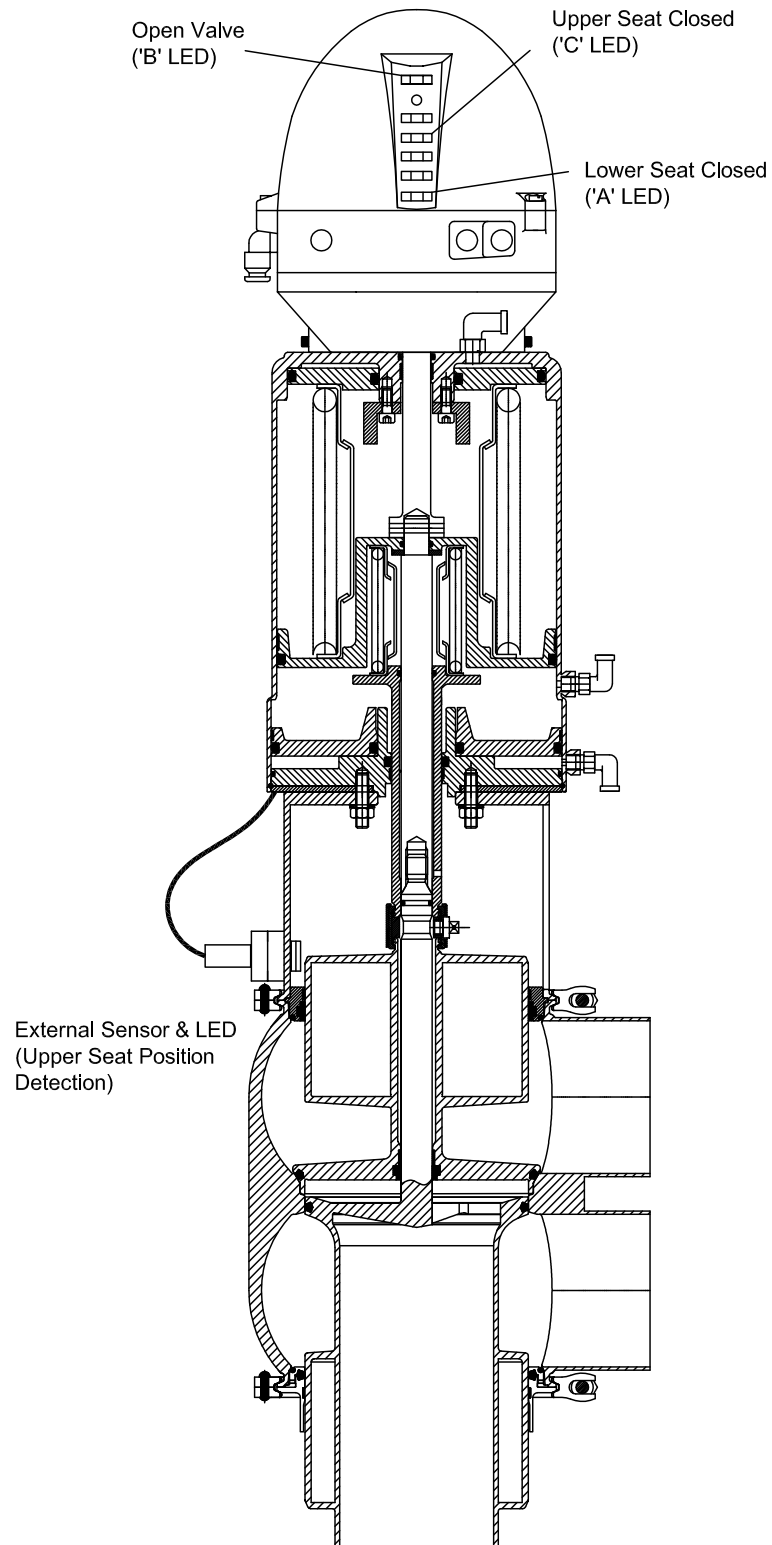

Unique PMO Plus[®] Series Mixproof Valve
ThinkTop[®], 8-30 VDC #9612-5789-01 (0 Solenoid)
Electrical Connection Chart

<u>ThinkTop Term. No.</u>	<u>Function</u>	<u>Remarks</u>
9	+8-30 VDC	Power +
10	-Common	Power -
	Ground	-----
1	Closed Valve	PLC Input - Valve Closed (Lower Seat)
2	Open Valve	PLC Input - Valve Open
3	Seat Lift - 1	PLC Input - Valve Closed (Upper Seat)
5	Status	PLC Input - Optional
24	Seat Lift-1 (Upper) (Signal)	External Sensor (WHT)
26	Supply +	External Sensor (BRN)
27	Supply -	External Sensor (BLU)
	Not Used -	External Sensor (BLK)

Unique PMO Plus® Series Mixproof Valve
 ThinkTop®, 8-30 VDC #9612-5789-54 (3 Solenoids)
Electrical Connection Chart

<u>ThinkTop Term. No.</u>	<u>Function</u>	<u>Remarks</u>
6	Solenoid - 1	Output - Valve Open
7	Solenoid - 2	Output - Lower Seat Push
8	Solenoid - 3	Output - Upper Seat Lift
9	+8-30 VDC	Power +
10	-Common	Power - *(Jump to 11)
11	Solenoid Com.	Power - *(Jump to 10)
	Ground	-----
1	Closed Valve	PLC Input - Valve Closed (Lower Seat)
2	Open Valve	PLC Input - Valve Open
3	Seat Lift - 1	PLC Input - Valve Closed (Upper Seat)
5	Status	PLC Input - Optional
24	Seat Lift-1 (Upper) (Signal)	External Sensor (WHT)
26	Supply +	External Sensor (BRN)
27	Supply -	External Sensor (BLU)
	Not Used -	External Sensor (BLK)

*One power supply, positive activation of solenoids.

Unique PMO Plus[®] Series Mixproof Valve
ThinkTop[®], 110 VAC #9612-9906-01 (0 Solenoid)
Electrical Connection Chart

<u>ThinkTop Term. No.</u>	<u>Function</u>	<u>Remarks</u>
9	110 VAC	Power +
10	-Common	Power -
	Ground	-----
1	Closed Valve	PLC nput - Valve Closed (Lower Seat)
2	Open Valve	PLC Input - Valve Open
3	Seat Lift - 1	PLC Input - Valve Closed (Upper Seat)
5	Status	PLC Input - Optional
24	Seat Lift-1 (Upper) (Signal)	External Sensor (Red w/BLK rings)
26	Supply +	External Sensor (Red w/WHT rings)

Unique PMO Plus® Series Mixproof Valve
 ThinkTop®, 110 VAC #9612-9906-74 (3 Solenoids)
Electrical Connection Chart

<u>ThinkTop Term. No.</u>	<u>Function</u>	<u>Remarks</u>
6	Solenoid - 1	Output - Valve Open
7	Solenoid - 2	Output - Lower Seat Push
8	Solenoid - 3	Output - Upper Seat Lift
9	110 VAC	Power +
10	-Common	Power - *(Jump to 11)
11	Solenoid Com.	Power - *(Jump to 10)
	Ground	-----
1	Closed Valve	PLC Input - Valve Closed (Lower Seat)
2	Open Valve	PLC Input - Valve Open
3	Seat Lift - 1	PLC Input - Valve Closed (Upper Seat)
5	Status	PLC Input - Optional
24	Seat Lift-1 (Upper) (Signal)	External Sensor (Red w/BLK rings)
26	Supply +	External Sensor (Red w/WHT rings)

*One power supply, positive activation of solenoids.



Instruction Manual

ThinkTop® Digital 8 - 30 VDC & 110 VAC PNP/NPN Used with **Unique PMO Plus®** Series Mixproof Valves

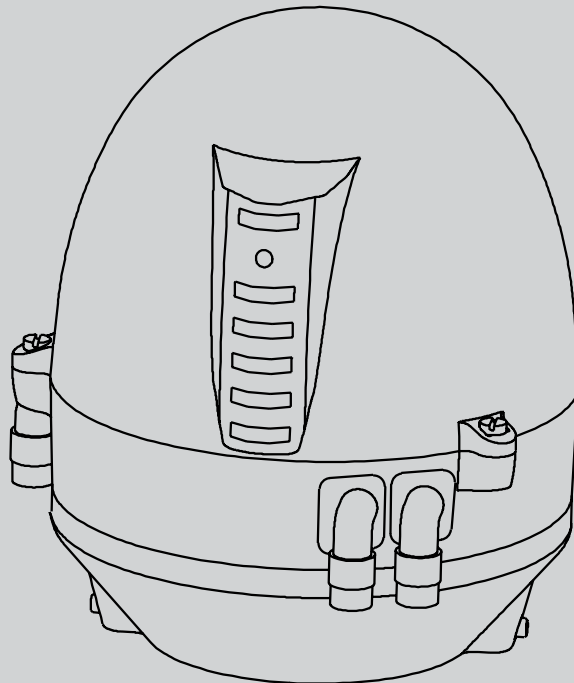

TD 800-006

ThinkTop®. Digital 8-30 or 110 VAC NO/NC**Features****Tolerance**

The tolerance band is ± 1.5 mm.

Built-In Maintenance Monitor

The unit can be preset to indicate when the time for maintenance of the valve has been reached. A status signal and flashing maintenance LED can be programmed to return after 3, 6, 9 or 12 months or more.

Other Features

Another very important fact is that the setup is kept until programmed otherwise even during failure in the power supply.

The accurate sensor system enables indication of seat lift to be integrated in the top unit.

Materials

Plastic Parts:	Nylon PA 12.
Steel part	Stainless steel AISI 304 and 316.
Seals	Nitrile (NBR). EPDM rubber for SMP-EC activator stem.

Technical Data

Sensor accuracy:	$\pm 0,1$ mm (0.0004 inch)
Distance to magnet:	5 ± 3 mm (0.12 \pm 0.2 inch)
Stroke length:	0.1 - 80 mm (0.004 - 3.15 inch)

Electrical Connection

Direct cable gland entry (hard wired) PG11 ($\varnothing 4$ - $\varnothing 10$ mm) ($\varnothing 0.16$ - $\varnothing 0.39$ inch).

Terminals

The terminal row of the sensor unit is equipped with screw terminals for both internal as well as external cables and wires. The terminals are suitable for wires up to 0.75mm² (AWG19).

Power Supply - AC

The **ThinkTop**® is designed to be a part of the PLC's Input/Output (I/O) system. It should be supplied from the same protected power supply as the other I/O devices. The I/O power supply should not be used for other kinds of loads.

The unit is reversed polarity and short circuit protected. The power supply must meet the requirements of EN 61131-2.

Supply voltage:	8-30 or 100 - 126.5 VAC
Supply voltage nominal:	24 or 110 VAC (+15%, -10%) - pr. EN 61131-2
Supply voltage absolute max:	30 or 126.5 VAC
Supply voltage absolute min:	8 or 100 VAC
Power consumption*):	Max. 1.5 VA (8-30 VAC) or max. 2.0 VA (110 VAC (for sensor unit along) (Exclud- ing current to the solenoids, external proximity switches and the PLC input current.)

*)The initial current during power-on is higher. Typical values are 440 mARCS during 10 ms (the first half cycle) followed by 270 ms at 2 x normal steady state current.

The fulfilling of the UL requirements in UL508 requires that the unit is supplied by an isolating source complying with the requirements for class 2 power units (UL1310) or class 2 and 3 transformers (UL 1585).

Feedback Signals

Output signals from the sensor unit to be connected digital interface (PLC).

Nominal voltage:	Must match the selected type of ThinkTop ®
Load current:	50 mA Typical, 100 mA max.
Voltage drop:	Typical 3V at 50 mA

External Sensors

The external sensors are used for seat-lift supervision when seat-lift cannot be internally detected. The sensors get their supply voltage from the terminal row. The output signals from the sensors are connected to two inputs on the terminal row on the internal sensor unit. If the actual setup is set for internal seat-lift, the corresponding external signal is not used, otherwise the external signal logically controls the corresponding feedback to the PLC.

Supply voltage:	Must match the selected type of ThinkTop ®.
Supply current:	Max. 15 mA per sensor.
Type of sensor:	2 wire VAC (EN60947-5-2)
Cable length:	Max. 3 m. (16.4 ft.)

Polarity

NO or NC function is selected with a jumper between terminals 12 and 13. Jumper present = NO. If changing to NC remove the jumper and make a power recycle. A power recycle is always required when changing this function.

ThinkTop[®] Digital 8-30 or 110 VAC NO/NC**Solenoid valves**

Up to 3 solenoid valves in each unit.

Type	3/2 or 5/2 valve (only with one 5/2 valve).
Air supply	300-900 kPa (3-9 bar) (43.5-130.5 PSI)
Filtered air, max. particules or dirt.....	0.01 mm (0.0004 inch).
Max. oil content.....	1.0 ppm.
Max. water content.....	0.0075 kg/kg air. (0.02 lb/lb)
Throughput°	Ø2.5mm
Air restriction (throttle function) air inlet/outlet.	

Manual hold override.

External air tube connection	Ø6 mm or ¼"
Silencer/filter*).....	Connection possible via Ø6 mm or ¼"
Nominal voltage.....	24 or 110V
Nominal power	1.0 W.

*) Filter recommended in tropical regions.

Micro environment demand specifications

Temperature		
Working:	-4°F to +185°F	IEC 68-2-1/2
Storage:	-40°F to +185°F	IEC 68-2-1/2
Temperature change:	-13°F to +158°F	IEC 68-2-14
Vibration		
10-55 Hz, 0.7 mm	IEC 68-2-6	
155-500 Hz, 10g		
3 x 30 min, 1 octave/min		
Drop test		IEC 68-2-32
Humidity		
Constant humidity	+104°F, 21 days, 93% R.H.	IEC 68-2-3
Cyclic humidity: (working)	+77°F/+131°F 12 cycles 93% R.H.	IEC 68-2-30
Protection class	IP67	IEC 529
Input treshold		
Voltage/current:	Type 1 input requirements	EN 61131-2
Solenoid signals		
Isolation voltage	(1000 + 2 x 117) VAC rms/1 min	EN 61131-2
EMC Directive	89/336/EEC	EN 50081-1, EN 50082-2
UL/CSA Approval		
	8-30 VAC	UL508-E203255
	110 VAC	UL 508-E223664

ThinkTop®. Digital 8-30 or 110 VAC NO/NC

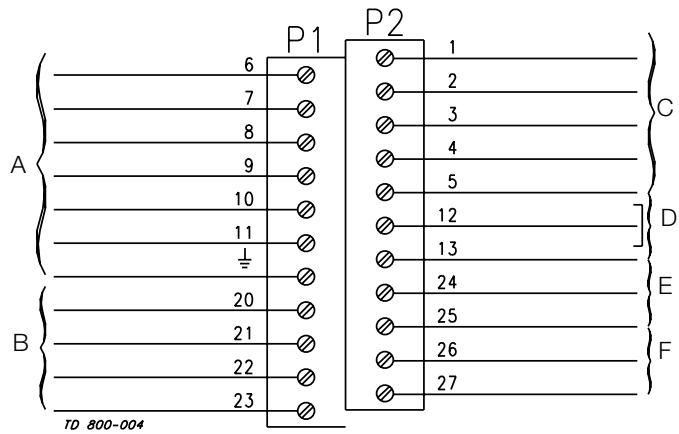

- A. Digital interface command signals
 - B. Internal connections to solenoid 1-3
 - C. Feedback signals to digital interface
 - D. Jumper connections **)
 - E. Incoming signals from external sensors
 - F. Support to external sensors
- | | |
|---------------------------|-----------------------------|
| 6. Solenoid 1 | 1. Closed valve |
| 7. Solenoid 2 | 2. Open valve |
| 8. Solenoid 3 | 3. Seat-lift 1 |
| 9. Supply ~ | 4. Seat-lift 2 |
| 10. Supply ~ | 5. Status |
| 11. Solenoid common Earth | 12. NO/NC Jumper |
| 20. Solenoid common Earth | 13. NO/NC Jumper |
| 21. Solenoid 1 | 24. Seat-lift 1*) "upper" ~ |
| 22. | 25. Seat-lift 2*) "lower" ~ |
| 23. | 26. Supply ~ *) com. ~ |
| | 27. Earth |

***) Note**

- Terminals 24, 25, 26 and 27 can be used for external seat-lift sensors as well as for any digital input. Always use an external NO sensor.
- Two external signals can be connected, they are associated with feedback signals 3 (seat-lift 1) and 4 (seat-lift 2). External sensor must always be a 8-30 or 110 VAC NO 2 wire sensor. Connect ~ common on terminal 26. The signals from the external sensors are associated as follows: sensor signal on terminal 24 (seat-lift 1) associated with feedback 3 (seat-lift 1), and sensor signal on terminal 25 (seat-lift 2) associated with feedback 4 (seat-lift 2).

*****) Note**

Jumper present = NO. The selection NO/NC is done by the jumper. If changing the function a power recycle is necessary.

Note!

Remember to isolate wires that are not in use.

Examples of connecting power supplies

One power for sensor system and solenoid valves:

Two power supplies, one for sensor system and one for the solenoid valves:

Step 1

- **Always** read the technical specifications thoroughly (see chapter 3).
- **Always** have the *ThinkTop*® electrically connected by authorized personnel.
- **Always** install the *ThinkTop*® before valve or relay is in a safe position.

Step 2

1. Fit the air fittings on actuator if not mounted.
2. Fit the activator stem (magnet) and tighten carefully by hand.

**Step 3**

1. Place the *ThinkTop*® on top of the actuator.
2. Make sure X-ring is mounted.

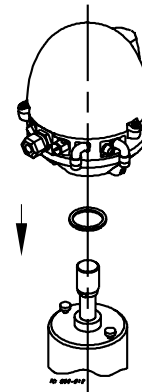
**Step 4**

1. Ensure that the unit is correctly mounted by pressing down on top of the *ThinkTop*®.
2. Tighten the two Allen screws carefully.
3. Turn the actuator to have LEDs in a front view.

Note:

After a relevant period of time after installation (e.g. two weeks) it is recommended to check that all connections are properly tightened.

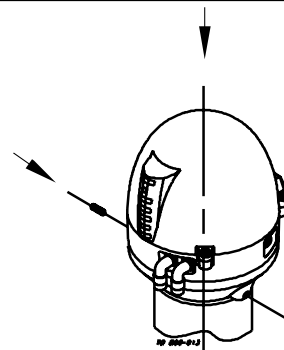

Step 5

Fit the $\varnothing 6$ mm (1/4") air tubes to *ThinkTop*® (see drawing "Air connections" on page 20).

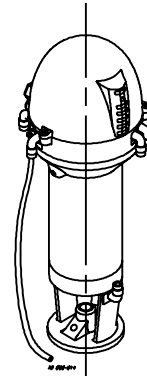

Step 6

Fit the air tubes to the actuator (see drawing "Air connections" on page 20).

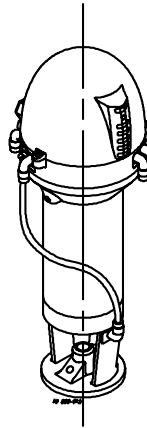

Step 7

Untighten the four screws and pull off cover of *ThinkTop*®.

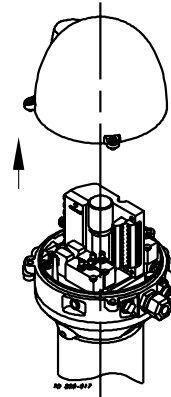

Step 8

1. Install cable (if not present) through the cable gland.
2. Connect the *ThinkTop*® electrically (see page 16).

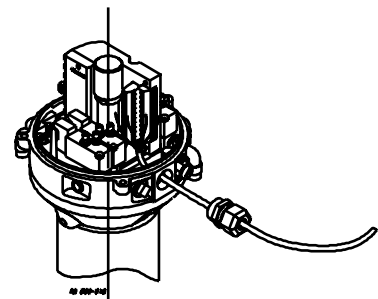

Step 9

Make sure the cable gland is completely tightened.

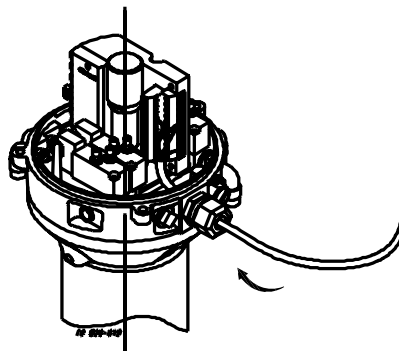
**Step 10**

Set up the *ThinkTop*® (see setup diagram page 21 and 22).

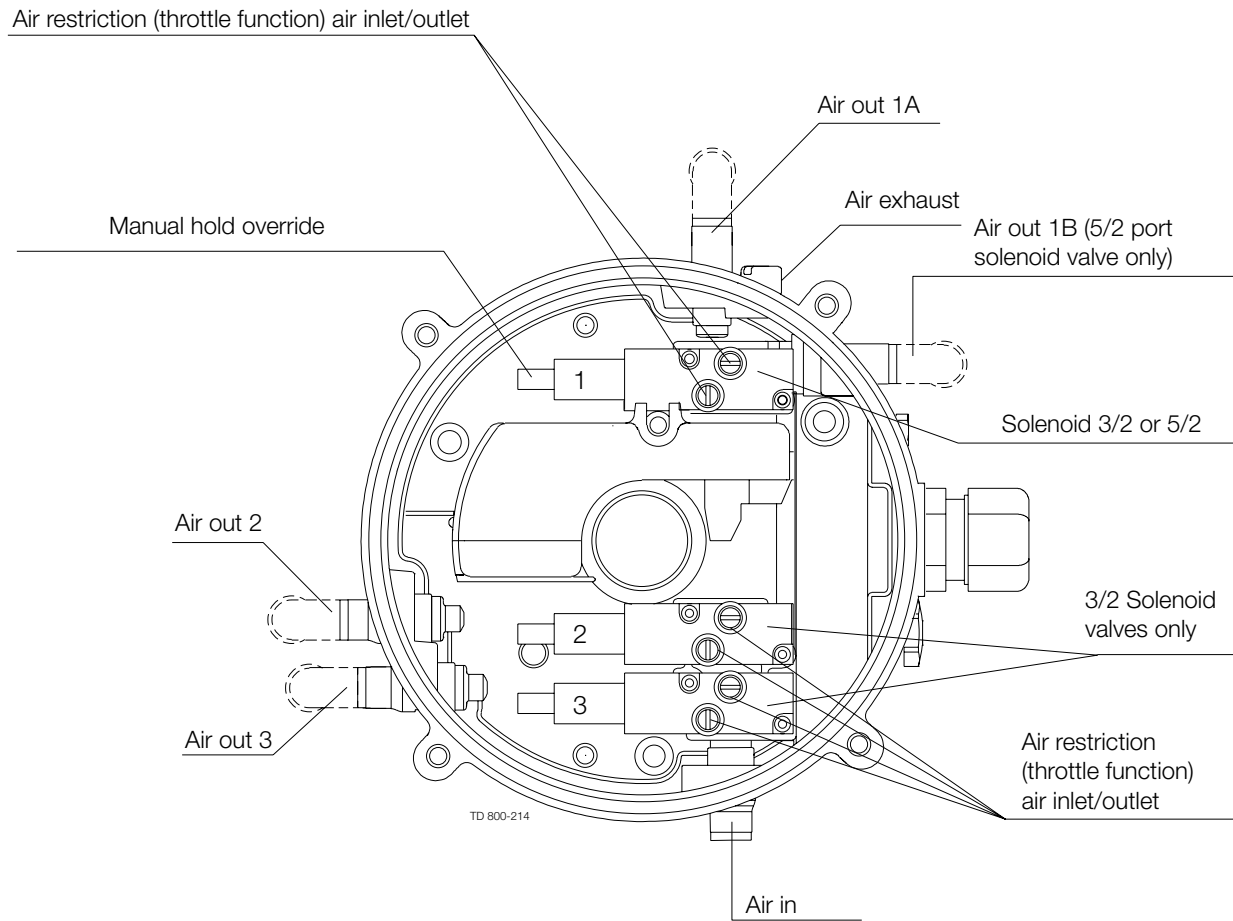

ThinkTop® setup utilizing local 'I' and 'II' Keys

- Notes:
- I ——— - Scroll across, no change
 - - Notes Requires Key Function
 - - Notes Automatic Progress as Indicated

- General:
1. Flashing IND means no value set. Steady IND means value set as shown.
 2. Default is: Step 2, Type 0 (+/- 5 mm) Step 3-8 disabled
 3. Lamp Status Shown in []

ThinkTop® Visual Indications

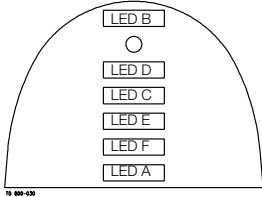

LED Indications

- "Open valve" (Yellow)
- "Setup/Internal fault" (Red)
- "Seat-lift 1/2" (Yellow)
- "Solenoid valves" (Green)
- "Maintenance" (Orange)
- "Closed valve" (Yellow)

4. [D] IND active during set-up.
 - Flashing in step 1,
 - Steady in all other steps.
 or during operations, error condition
 - Steady showing hardware fault
 - Flashing showing software fault
5. Timeout: A 60 second time-out is started as soon as any button(s) are released. If no button is pressed during the time-out time, go to normal condition (cancel & exit).

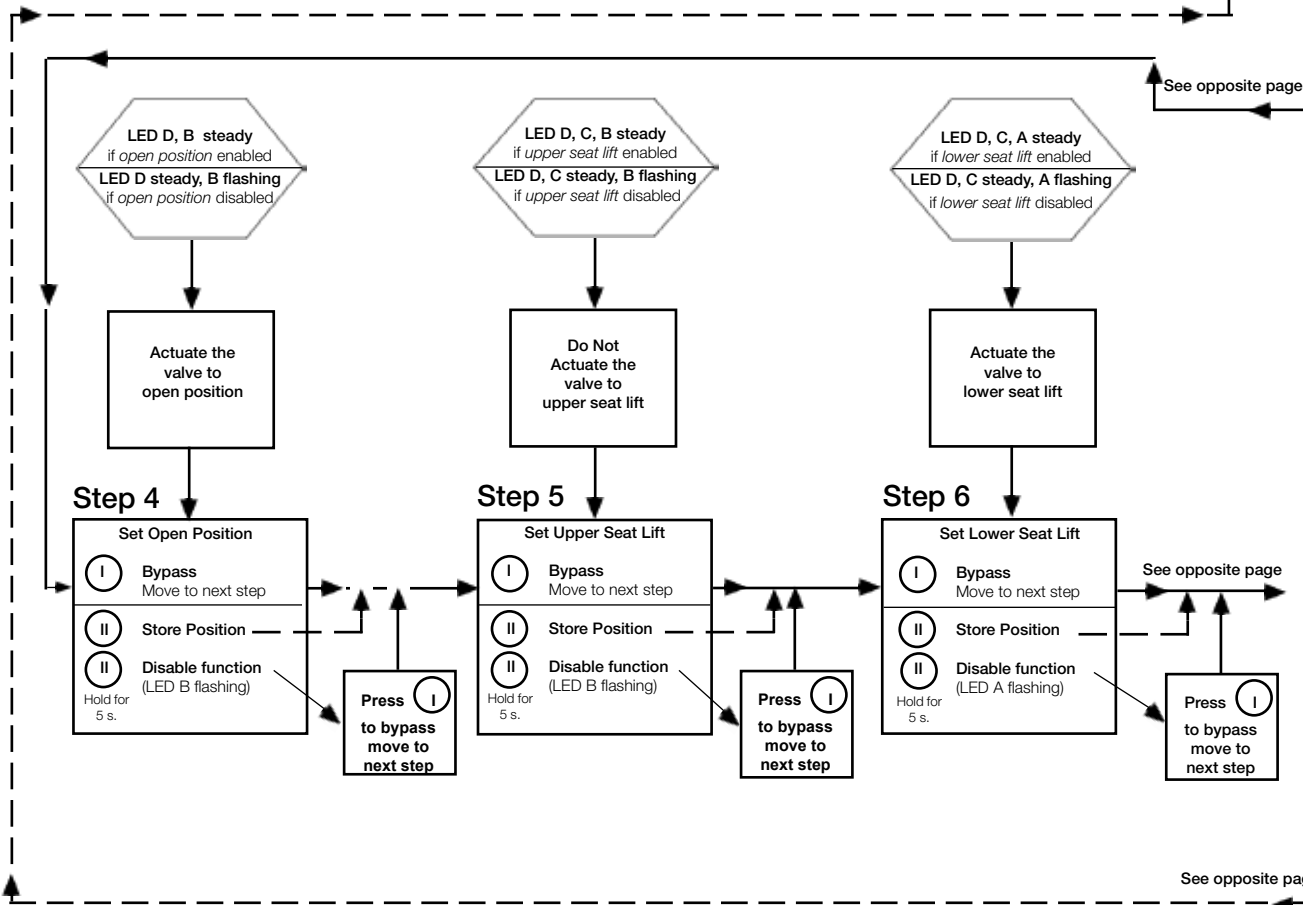
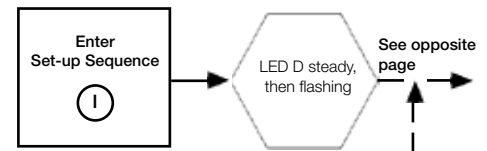

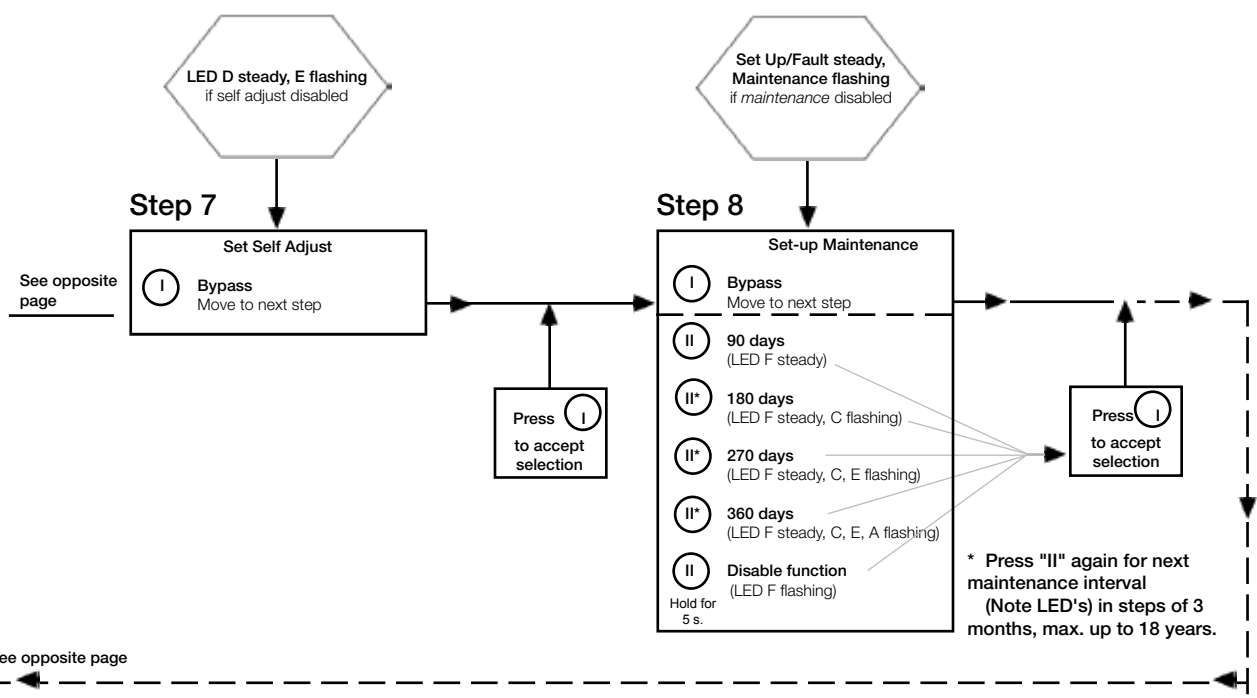
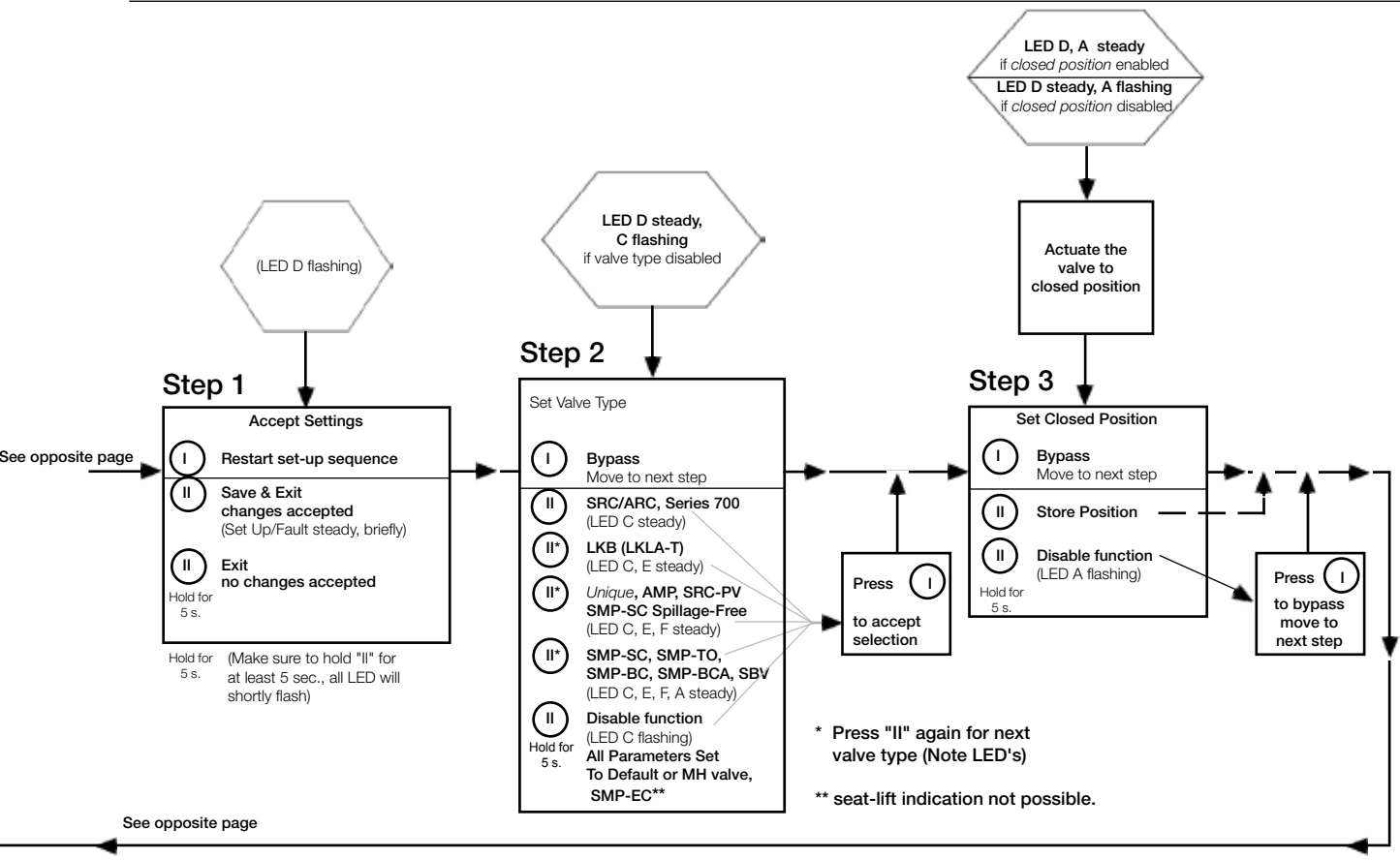

Below is stated the meaning of the LEDs' indications for fault finding in connection with the operation of the *ThinkTop*®.

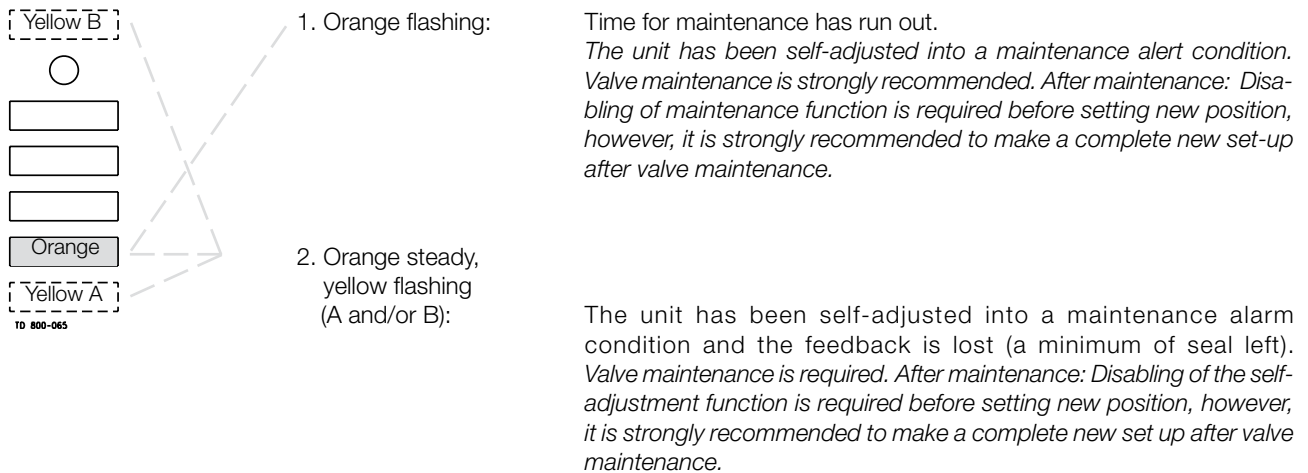
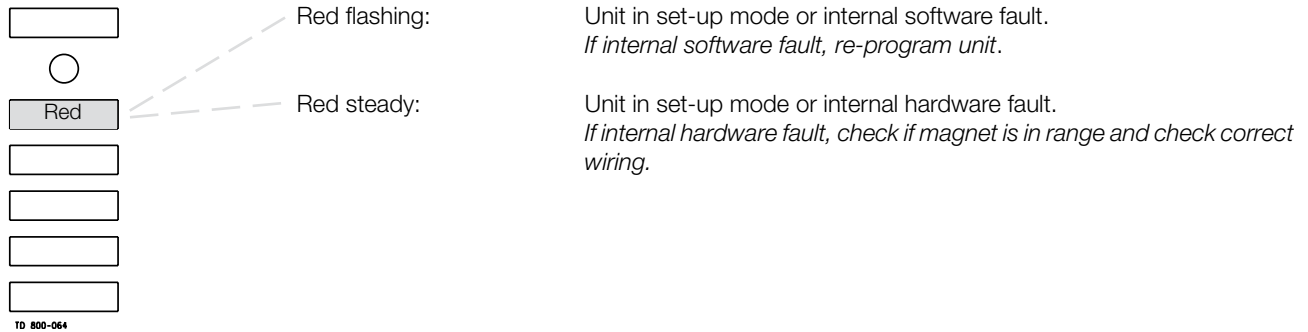

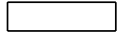
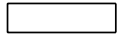
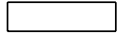
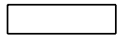

TD 800-064

Yellow steady:

Position A (closed valve).

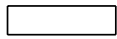
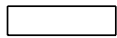
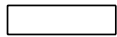
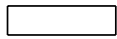

TD 800-064

Yellow steady:

Position B (open valve).

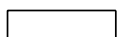
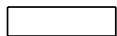
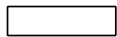

TD 800-064

Yellow steady:
Green steady:

Position C (Seat lift 1-2 or external sensors).
Solenoid valves activated.

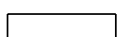
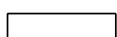
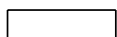
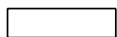
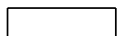

TD 800-064

Note: During set-up LED lights have different functions.

Study the instructions carefully.
 Handle scrap correctly.
 Always keep spare X-rings in stock.

Step 1

1. Remove the *ThinkTop*® from the actuator.
2. Pull out X-ring and replace it.

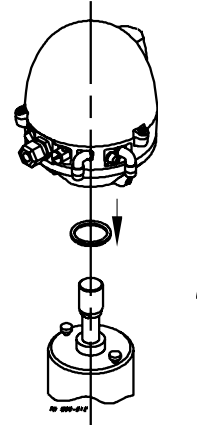

Step 2

1. Untighten the four screws.
2. Pull off cover of *ThinkTop*®.

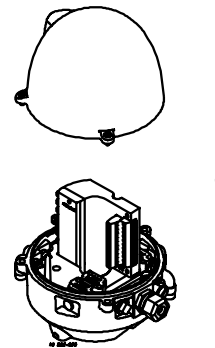

Step 3

1. Untighten screws.
2. Remove solenoid valves (up to three) and replace them with new ones.

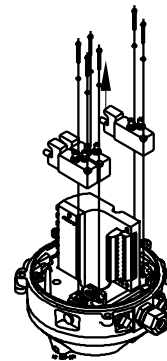

Step 4

1. To dismantle the adapter (the lower part of the *ThinkTop*®) from base (the middle part), unscrew the three screws.
2. Turn the lower part a little clockwise and pull.
3. Replace adapter if necessary.

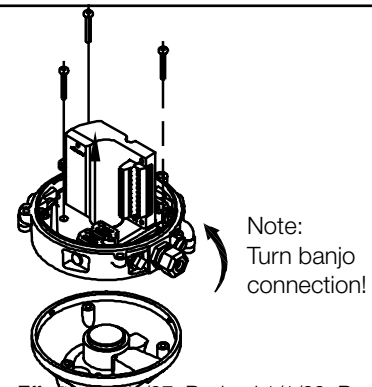

*Study the instructions carefully.
Handle scrap correctly.
Always keep spare X-rings in stock.*

Step 5

To remove the sensor unit untighten screw and pull out the sensor unit.

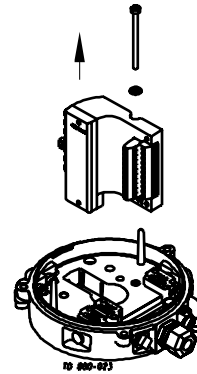

Study the instructions carefully.
 Handle scrap correctly.
 Always keep spare X-rings in stock.

Step 1

Place sensor unit in base and tighten screw (torque: 1 Nm).

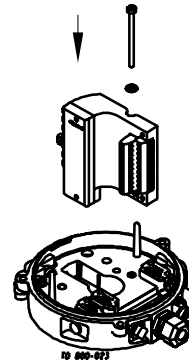

Step 2

Assemble base with adapter by turning adapter slightly anticlockwise and tighten the three screws (1.9 Nm).

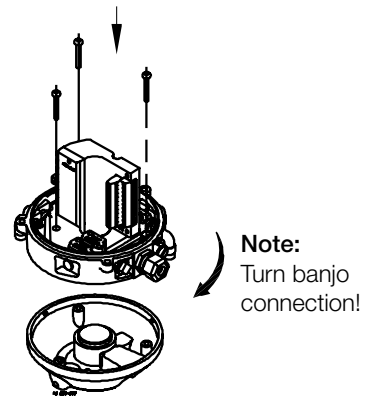

Step 3

1. Replace solenoid valves (up to three) with new ones.
2. Tighten screws (0.2 Nm).

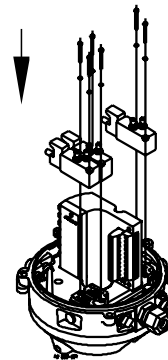

Step 4

Replace cover of ThinkTop® and tighten the four screws (0.6 Nm).

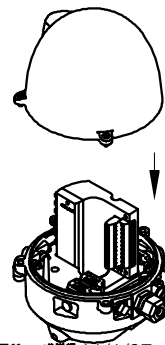

Study the instructions carefully.
Handle scrap correctly.
Always keep spare X-rings in stock.

Step 5

1. Replace X-ring.
2. Mount *ThinkTop*® on actuator.

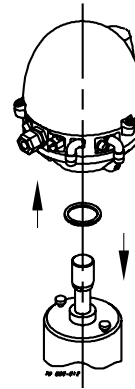



Spare Parts

ThinkTop®

P/N 9612578901 } 8-30 VDC
P/N 9612578954 }

P/N 9612990601 } 110 VAC
P/N 9612990674 }

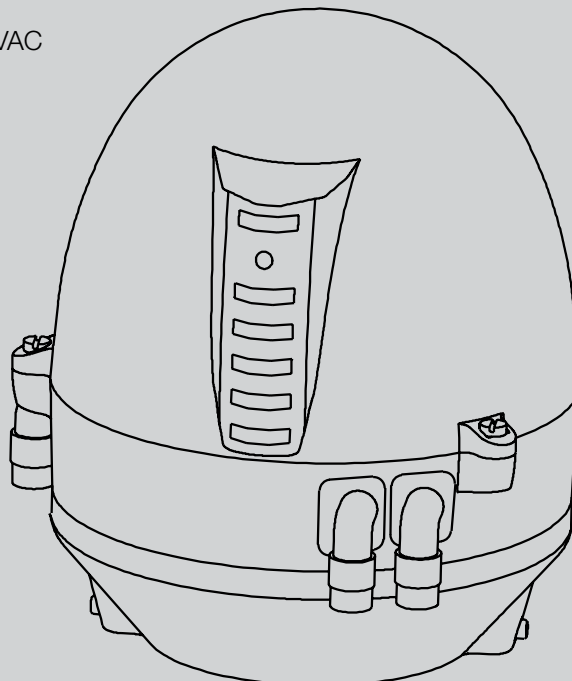

TD 800-006

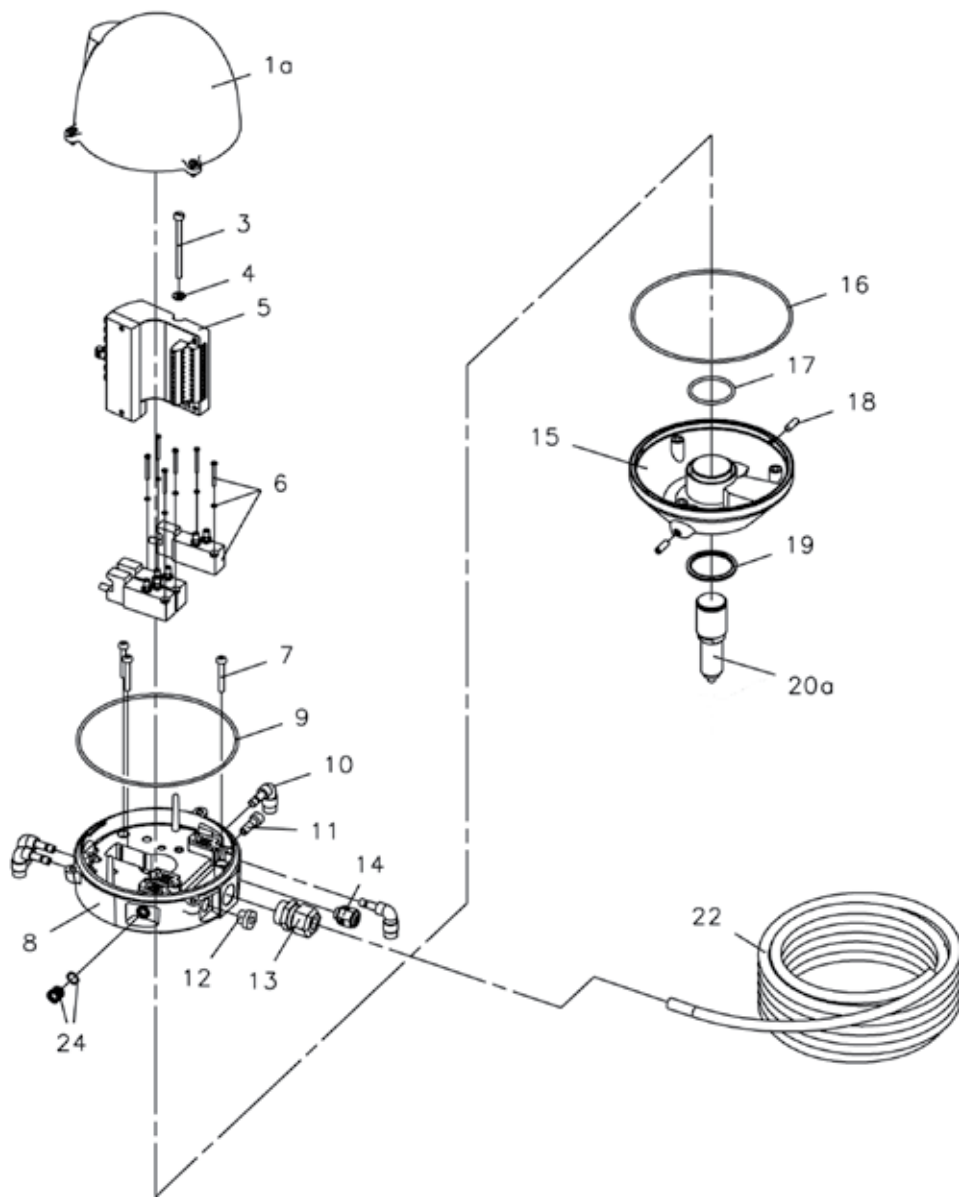

Pos.	Qty.	Denomination	Unique PMO ® Series Mixproof	¼" Air Connection
1a	1	Shell complete	9613-4279-01	
3	1	Screw	9611-99-3458	
4	1	Washer	9611-99-3459	
5	1	Sensor unit Digital 8-30 VDC PNP/NPN	9612-5627-01	
5	1	Sensor unit Digital 110 VAC NO/NC	9612-5627-05	
6	1-3	Solenoid valve 3/2, 24 VDC	9611-99-3324	
6	1-3	Solenoid Valve 3/2, 110 VAC	9611-99-3326	
7	3	PT screw	9611-99-3457	
8	1	Base complete, 3/2, no solenoids (Pos. 9, 12, 13, 14 Included)		9613-4282-01
8	1	Base complete, 3/2, 24 VDC, three solenoid (Pos. 9, 10, 11, 12, 13, 14 Included)		9613-4282-11
8	1	Base complete, 3/2, 110VAC, three solenoids (Pos. 9, 10, 11, 12, 13, 14 Included)		9613-4282-13
8	1	Base prepared for no solenoid		9612-5761-01
9	1	Special X-Ring	9613-4564-01	
10	1	Air fitting		9611-99-3433
11	1	Blow-off valve	9612-5636-01	
12	1	Thread Plug, PG7	9611-99-3407	
13	1	Cable gland, PG11, 4-10mm	9611-99-3517	
14	1	Gore Vent High Airflow	9611-99-4722	
15	1	Adapter complete (Pos. 17, 18, 19)	9612-5621-01	
16	1	Special X-Ring	9612-9994-01	
17	1	O-ring	9611-99-3350	
18	2	Allen screw	9611-99-3409	
19	1	Special X-ring	9612-5696-01	
20a	1	Indication pin complete	9612-5623-01	
22	1	5m. flying PVC cable (12x0.5 mm ²) Digital	9611-99-3627	
24	1	Air fitting incl. O-ring		9611-99-3434

Recommend Cleaning – General

In order to be compliant with the Pasteurized Milk Ordinance (PMO), the *Unique **PMO Plus***[®] Series mixproof valves shall be cleaned-in-place (CIP) with the following recommended procedures.

Each mixproof valve shall be properly operated, including seat lifting, during CIP cleaning to assure exposure to product contact surfaces.

Recommend Cleaning – Specific

The chart below provides reference to cleaning solution agents, temperature and exposure times necessary during circulation to achieve good cleaning results.

All data shown is required for **each** valve during cleaning.

Use clean water, free from chlorides, for mixing with chemical cleaning agents.

CIP Event	Exposure Time	Temperature	Agent	Concentration
Warm Pre-Rinse	3 minutes continuous	100 - 110 °F	None	None
Hot Alkaline Wash	10 minutes continuous	160 °F	NAOH (sodium hydroxide)	.265 gal.+ 26.5 gal. water. (1%)
Cold Post Wash Rinse	3 minutes continuous	Cold	None	None
Cold Acidified Rinse	3 minutes continuous	Cold	HNO3 (nitric acid)	.18 gal. + .265gal. water. (.006%)

Valve Pneumatic Operation During In-Place Cleaning (*Unique PMO Plus*® Series)

Each valve seat shall be lifted during the length of the cleaning cycle. Seat lift durations shall not exceed 10 seconds.

These pneumatic functions include:

1. upper valve seat lift. (Cleaning of upper valve house)
2. lower valve seat push (Cleaning of lower valve house)

The following chart presents an overview of these functions together with the recommended time durations.

CIP Event @ Length	Valve Function	Valve Solenoid No.	Solenoid Mode	PLC Timer Duration	Total Valve Functions Over 3 Minute Rinses and 10 Minute Washes
Warm Pre-Rinse @ 3 Minutes	Upper Seat Lift	3	Energized	*5 sec	2
	Lower Seat Push	2	Energized	*5 sec	2
Hot Alkaline Wash @ 10 Minutes	Upper Seat Lift	3	Energized	*5 sec	5
	Lower Seat Push	2	Energized	*5 sec	5
Cold Post Wash Rinse @ 3 Minutes	Upper Seat Lift	3	Energized	*5 sec	2
	Lower Seat Push	2	Energized	*5 sec	2
Cold Acidified Rinse @ 3 Minutes	Upper Seat Lift	3	Energized	*5 sec	2
	Lower Seat Push	2	Energized	*5 sec	2

*Approximately 2 seconds actual seat push average based upon 5 second PLC timer duration.

Note: *Unique PMO Plus*® Series valves can be thoroughly cleaned under gravity (atmospheric) or, pressure from the cleaning solution source pump, using seat lifting operations of the upper and lower plug seats.

Guide Bearing Cleaning

When the valves are removed for replacement of wetted parts and / or sealing elastomers, it is important to remove, and hand clean, the three PTFE guide rings (positions 45, 54, 80) and their seating grooves before placing the valves back into service.

See section, Maintenance, Re-Assembly Valve (points 1, 2, 5, 6, 24 and 25)

Unique PMO Plus[®] - Upper Seat Lift and Lower Seat Push

Unique PMO Plus[®]-CP - Upper Seat Lift

Flow of Cleaning Solution Through Valve Vent Tube (example)

The table below approximates the flow of cleaning solution through the valve vent tube during seat lift functions at 30 PSI CIP pressure.

(viscosity and density comparable to water)

Valve Size	Flow Per Second Through Vent Tube	Flow Every 2 Seconds Through Vent Tube
1½"	21 Ounces	42 Ounces (.33 gal.)
2"	31 Ounces	62 Ounces (.48 gal.)
2½"	45 Ounces	90 Ounces (.70 gal.)
3"	45 Ounces	90 Ounces (.70 gal.)
4"	61 Ounces	122 Ounces (.95 gal.)
6"	142 Ounces	284 Ounces (2.22 gal.)

Note: Refer to page 9 "CIP Solution Flows for seat lift" to determine flows for CIP pressures other than 30 PSI shown above.

Unique PMO Plus[®] CP - Lower Seat Push

Flow of Cleaning Solution Through Valve Vent Tube/O.D. Balancer (example)

The table below approximates the flow of cleaning solution through the valve vent tube and O.D. cleaning element during lower seat push functions at 30 PSI CIP pressure.

(viscosity and density comparable to water)

Valve Size	Flow Per Second Through Vent Tube	Flow Every 2 Seconds Through Vent Tube
1½"	27 Ounces	54 Ounces (.42 gal.)
2"	53 Ounces	106 Ounces (.83 gal.)
2½"	69 Ounces	138 Ounces (1.1 gal.)
3"	69 Ounces	138 Ounces (1.1 gal.)
4"	87 Ounces	174 Ounces (1.4 gal.)
6"	162 Ounces	324 Ounces (2.53 gal.)

Note: Refer to page 9 "CIP Solution Flows for seat lift" to determine flows for CIP pressures other than 30 PSI shown above.

Test - 1 Upper Valve Seat Position Detection

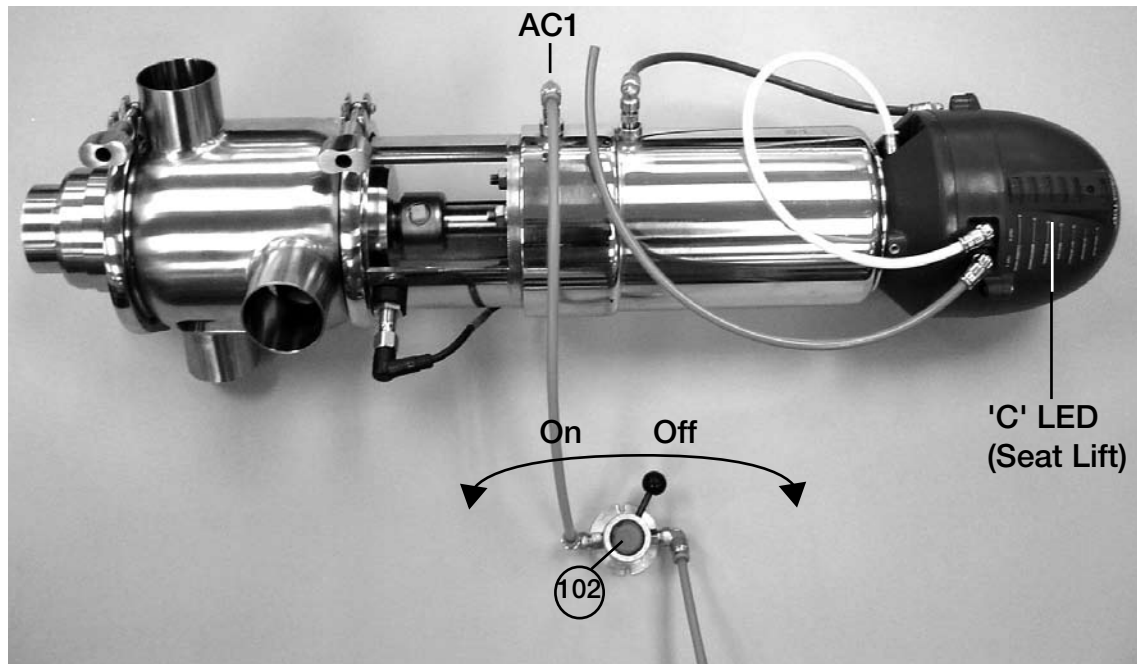

1. Valve at rest (closed) position
 - "C" LED (Seat Lift) on *ThinkTop* is illuminated.
2. Attach a manual air line to actuator air fitting AC1 using a 3-way air pilot switch (pos. 102).
3. Turn the air pilot switch to ON. (Open)
 - "C" LED (Seat Lift) on *ThinkTop* not illuminated.
4. Turn the air pilot switch to Off (Closed).
 - "C" LED (Seat Lift) on *ThinkTop* is illuminated.
5. Test complete. Remove manual air line.

Test - 2
Lower Valve Seat
Position Detection

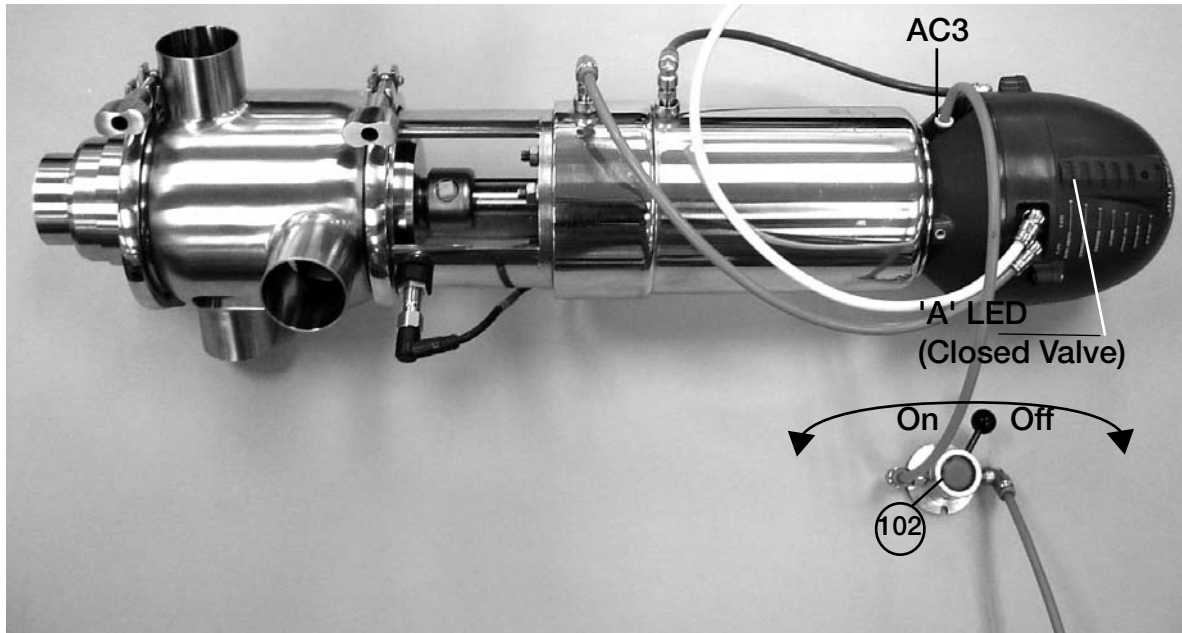

1. Valve at rest (closed) position
 - "A" LED (Closed Valve) on *ThinkTop* is illuminated.
2. Attach a manual air line to actuator air fitting AC3 using a 3-way air pilot switch (pos. 102).
3. Turn the air pilot switch to ON (Open)
 - "A" LED (Closed Valve) on *ThinkTop* not illuminated.
4. Turn the air pilot switch to Off (Closed).
 - "A" LED (Closed Valve) on *ThinkTop* is illuminated.
5. Test complete. Remove manual air line.

Adjustments

Upper Valve Seat External Sensor (24VDC or 110VAC)
(Position Data Existing on *ThinkTop*)

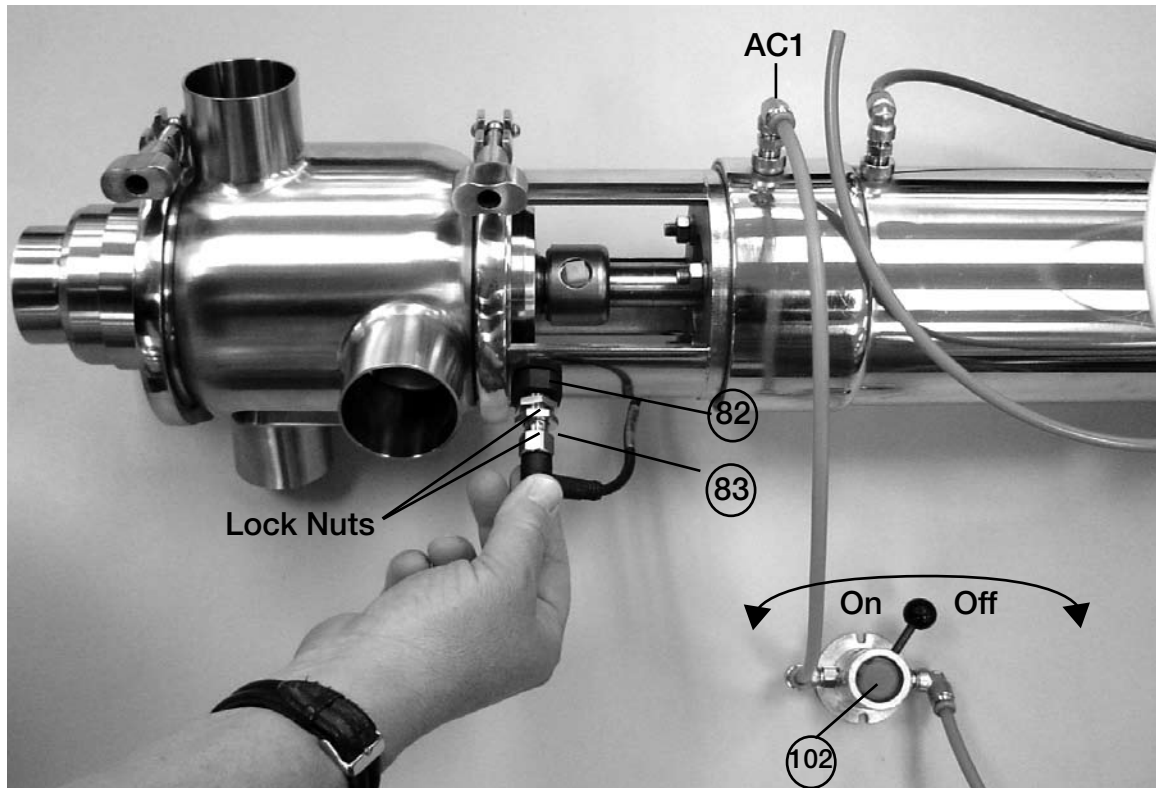

The following instructions should be made while the valve is hot from CIP cleaning.
(worst case)

1. Valve is in a rest position.
2. Loosen sensor lock nut(s).
3. Turn the sensor (pos 83) clockwise to bottom of nylon plug (pos 82), (or, in some cases, until the sensor LED turns off.)
4. Turn the sensor (pos 83) counter clockwise until the sensor LED turns on, (or approximately one full turn from bottom of plug.)
5. Lightly tighten sensor lock nut(s).
6. Attach a manual air line to actuator fitting AC1 using a 3-way air pilot switch (pos 102).
7. Turn the air pilot switch to ON (open). Upper seat lift activated. Sensor LED turns off.
8. Turn the air pilot switch to OFF (closed). Upper seat lift de-activated. Sensor LED turns on.
9. Turn the air pilot switch ON and OFF several times to verify sensor LED actions as listed in steps 7 and 8 above.
10. Moderately tighten sensor lock nut(s).
11. Repeat step 9 when the valve is cold and re-adjust with valve hot if necessary.

Adjustments

Upper Valve Seat *ThinkTop*
(Set Position New on *ThinkTop*)

The following instructions can be completed while the valve is at room (ambient) temperature.

1. Enter new 'UPPER SEAT LIFT' position data to the *ThinkTop* memory in step 5 of the programming sequence using the 'I' and 'II' keys.

Note: Data entry is done with the valve deactivated (Closed).

2. Adjust lateral sensor per instructions for 'UPPER VALVE SEAT EXTERNAL SENSOR' in this section.

Refer to "Electrical Connections/Instructions" in this manual for *ThinkTop* programming.

Adjustments

Lower Valve Seat *ThinkTop*

The following instructions can be completed while the valve is at room (ambient) temperature.

1. Delete the current 'CLOSED VALVE' position data from the *ThinkTop* memory using the 'I' and 'II' keys.
2. Enter new 'CLOSED VALVE' position data to the *ThinkTop* memory using the 'I' and 'II' keys.
3. Repeat 'Test - 2, Lower Valve Seat Position Detection' procedures to confirm adjustment.

Refer to "Electrical Connections/Instructions" in this manual for *ThinkTop* programming.

Test - 3
Regulatory Inspection,
Confirm Control System Seat Lifting
Interlock During an Operating, active CIP Circuit

Description of components to be used for this test:

1. *ThinkTop*® (blue control module located on top of the air actuator)
2. Compressed air solenoids (when furnished inside *ThinkTop*®**) see page 20 for top view of solenoid layout inside *ThinkTop*®.
 - a. Solenoid-1, valve full open. (Note: not used for this test procedure)
 - b. Solenoid-2, lower seat push activation.
 - c. Solenoid-3, upper seat lift activation.

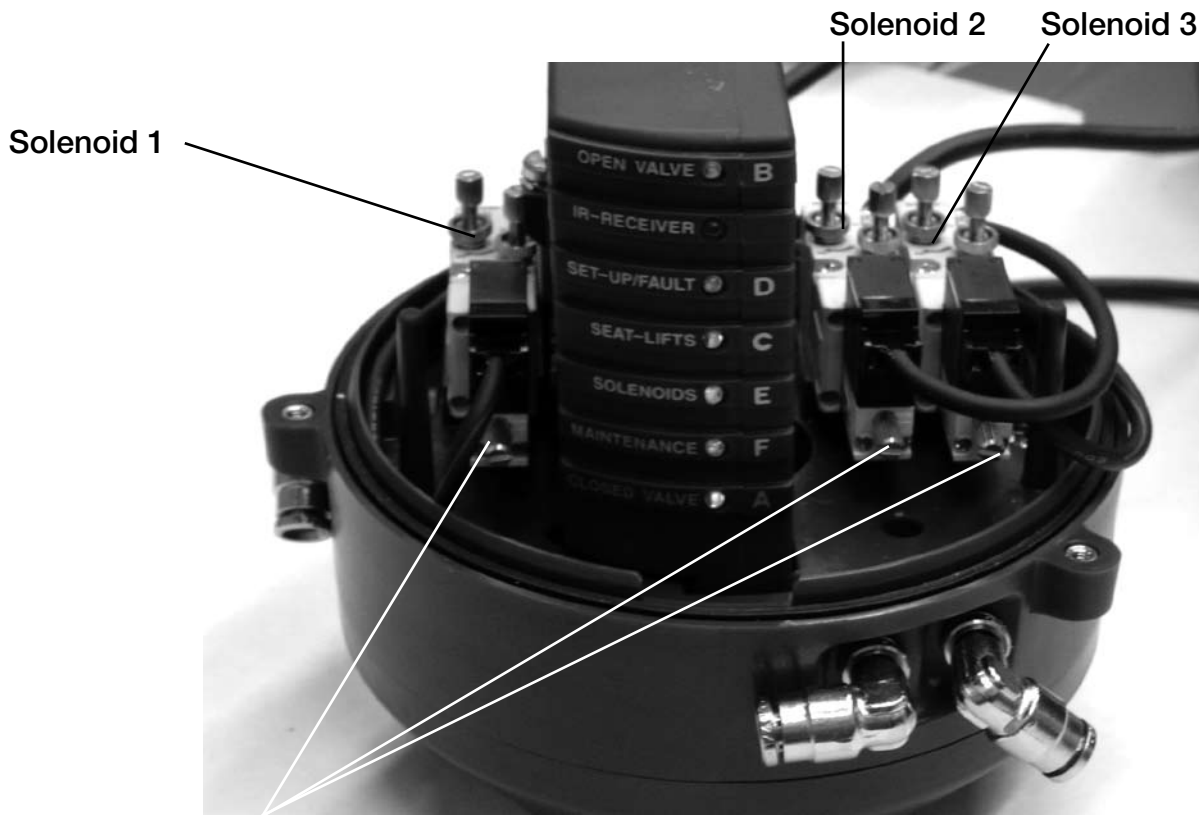

Manual Air Pilot Buttons

Test procedure listed as follows:

1. Select a Unique PMO Plus mixproof valve for interlock testing.
2. Decide if the cleaning solution will flow through the mixproof valve upper or lower body as part of the CIP cleaning circuit for the test.
3. Start the appropriate CIP circuit. (WARNING: be sure that there is no risk of mixing product with cleaning solution when conducting this test!!)
4. The CIP supply pump, or source of CIP solution pressure, should now be operating.
5. Remove the cover lid from the Think Top.

Move to step 6 or 7 below:

6. If cleaning solution is flowing through the valve upper body, push and hold the silver manual air pilot button on solenoid number 2 (lower seat push). If control system interlock is correct, the CIP supply pump, or source of CIP solution pressure, will be de-activated. Release manual air pilot button to end this test.
7. If cleaning solution is flowing through the valve lower body, push and hold the silver manual air pilot button on solenoid number 3 (upper seat lift). If the control system interlock is correct, the CIP supply pump, or source of CIP solution pressure, will be de-activated. Release manual air pilot button to end this test.
8. If the control system does NOT de-activate the cleaning solution pressure source as described in either 6 or 7 above, the control system should be shut down for evaluation, and correction, to the interlock functions written in the PLC logic.

** If solenoids are located in a remote enclosure (not inside Think Top), the above test procedures are to be conducted in exactly the same method. Selection of the proper solenoids for testing are to be determined using the assistance of plant operating personnel.

*General Maintenance:**Replace all product wetted seals every 12 months.*

Tools Required for Valve Service

- 16mm Wrench
- Strap Wrench
- 8mm Wrench
- 17mm Wrench
- 2.5mm Allen Wrench
- Small Knife
- Straight Pick
- Small Standard Screw Driver
- Air Pilot Switch (Pos. 102)

Tools Required for Actuator Service

- 13mm Wrench
- Long Stem Phillips Screw Driver (#2 Point)
- Plastic Hammer
- Small Blunt Face Punch
- Small Standard Screw Driver

Dis-Assemble Valve (Excluding Actuator)

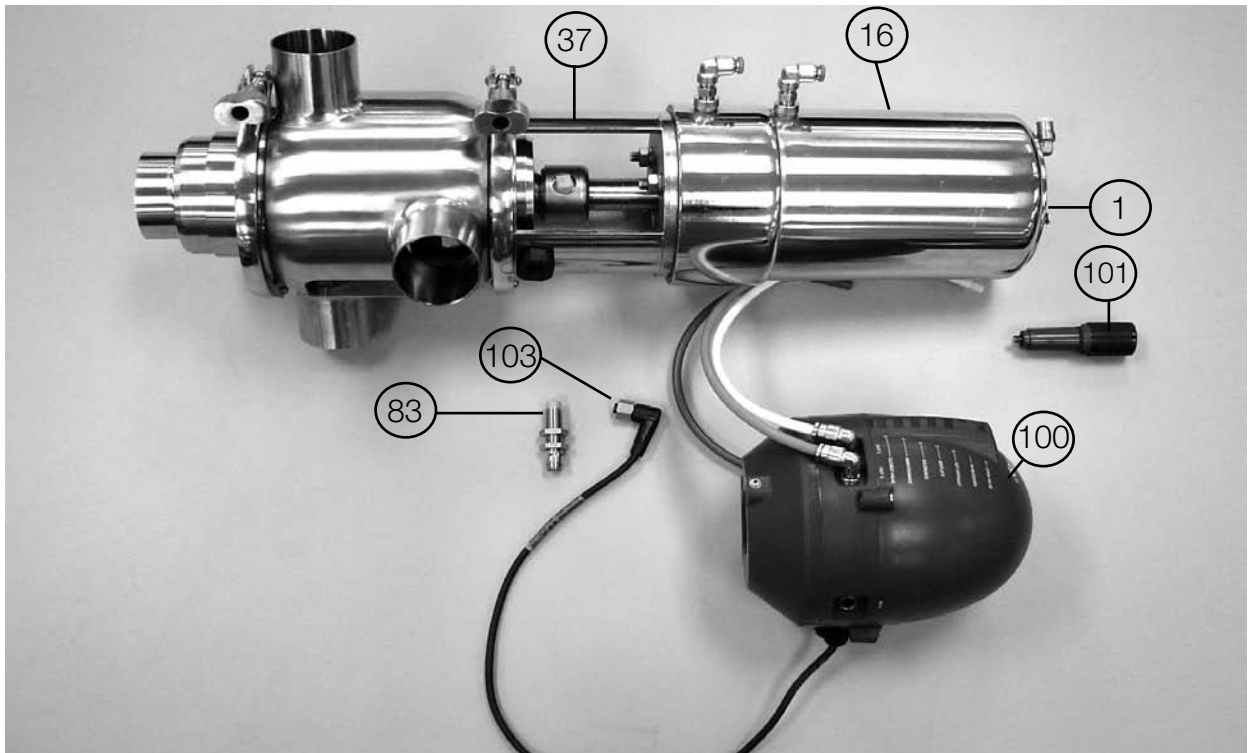

1. Remove *ThinkTop* (100).
2. Turn magnet (101) counter clockwise by hand and remove from upper actuator stem (1).
3. Turn nut on sensor cable (103) counter clockwise and remove.
4. Turn sensor (83) counter clockwise and remove.

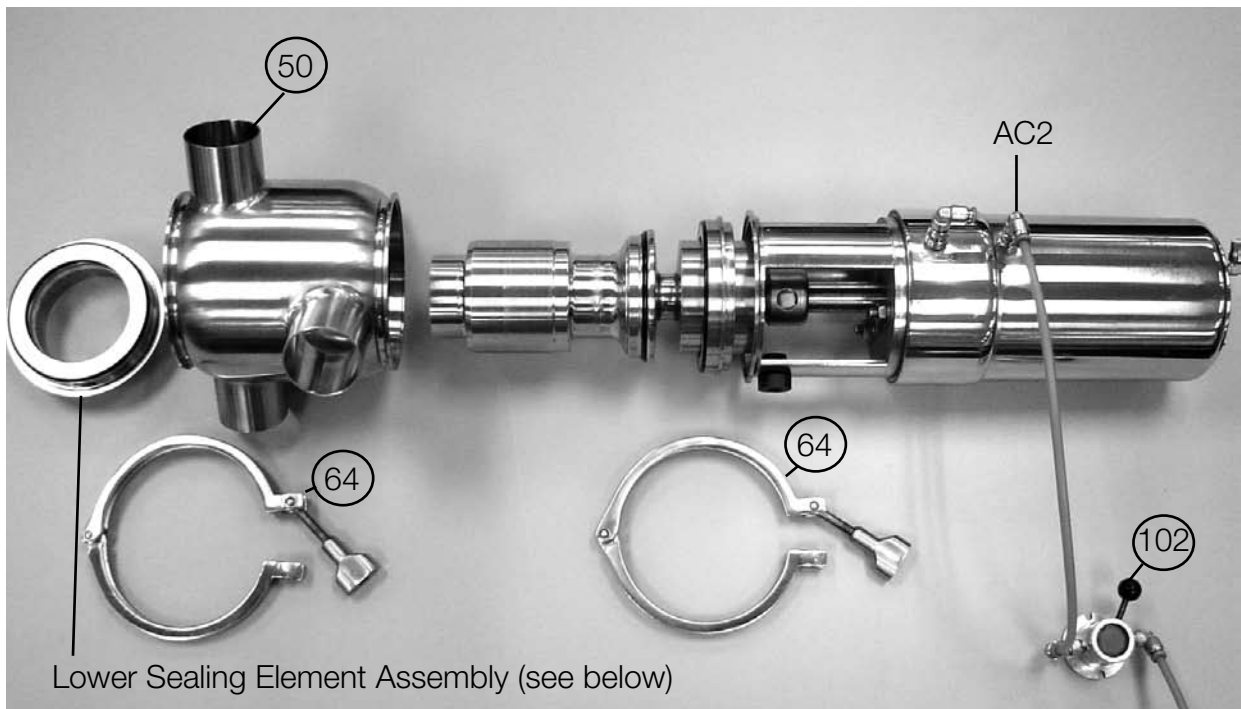

***Unique PMO Plus® - CP**

Unique PMO Plus®

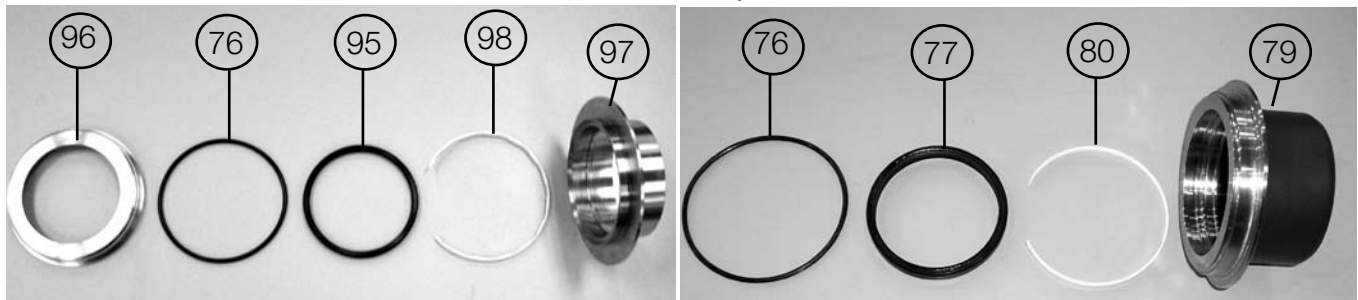

5. Supply compressed air to AC2 (blue ring).
 6. Remove upper clamp (64).
 7. Lift out the actuator together with the internal valve parts from the body (50).
 8. Release compressed air.
 9. Remove lower clamp (64).
 10. Remove lower sealing element assembly.
 11. Remove O-ring (76) from element (79) -or- from element *(96).
 12. Remove lip seal (77) from element (79)
 13. Remove guide ring (80) from element (79).
- OR-**
14. Remove seal *(95) from element *(97) and *(96).
 15. Remove guide ring *(98) from element *(97).

See pages 68 to 73 for part numbers.

Effective 11/1/07, Revised 1/1/09, Revised 8/1/09

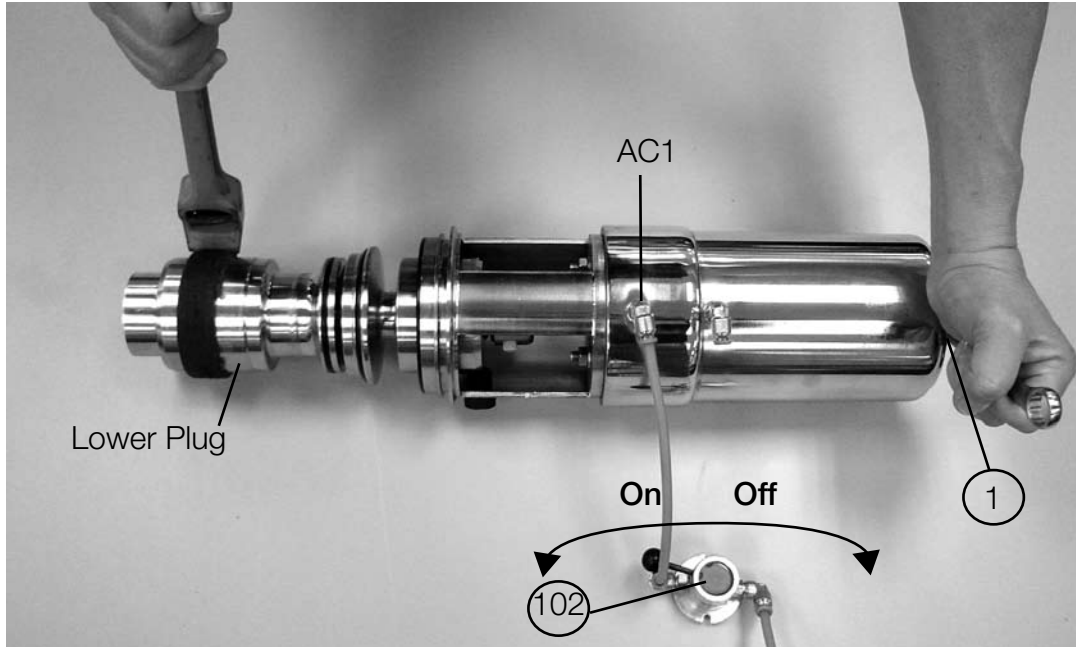

- 16. Supply compressed air to AC1 (Red Ring).
- 17. Loosen lower plug counter clockwise using a strap wrench while counter holding upper actuator stem (1) with a 16mm wrench.

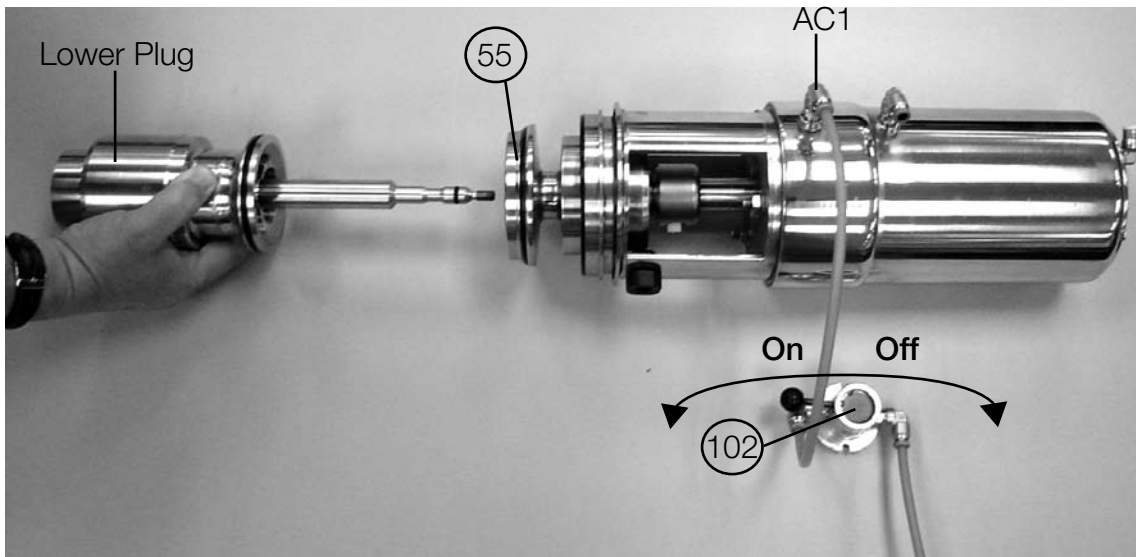

- 18. Turn counter clockwise by hand and remove lower plug.
- 19. Release compressed air.

See pages 68 to 73 for part numbers.

Unique PMO Plus®

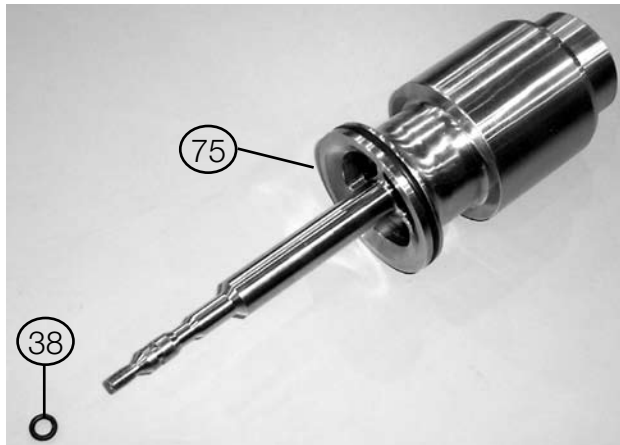

***Unique PMO Plus® - CP**

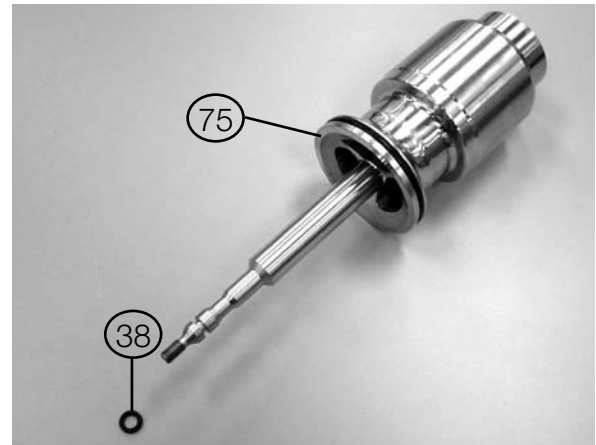

20. Remove O-ring (38) from lower plug stem (75).

21. Remove plug (15).

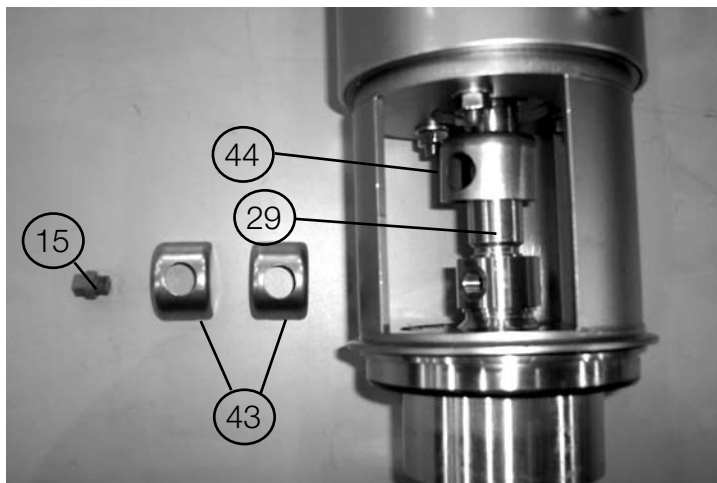

22. Slide lock (44) along piston rod (29).

23. Remove two clamps (43).

24. Pull upper plug (55), and upper sealing element (48) out.

25. Remove spindle liner (42).

26. Remove lock (44).

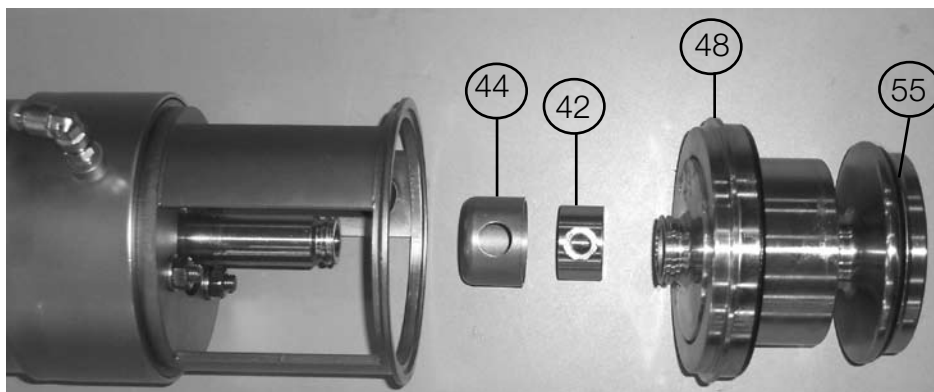

See pages 68 to 73 for part numbers.

Effective 11/1/07, Revised 1/1/09, Revised 8/1/09

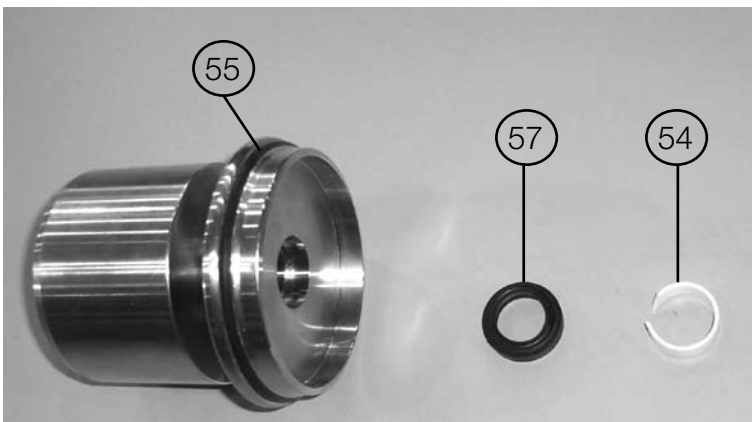
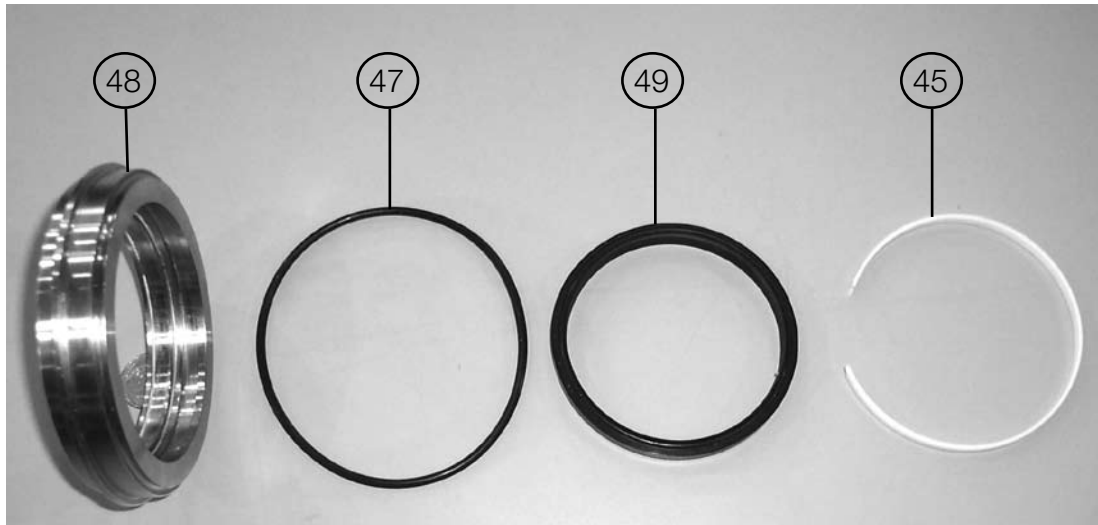

- 27. Remove O-ring (47).
- 28. Remove lip seal (49).
- 29. Remove guide ring (45).
- 30. Remove lip seal (57).
- 31. Remove guide ring (54)

Study the instructions carefully. Handle scrap correctly.

3. Replacement of seal ring, lower plug

Step 1

Cut and remove old seal ring (74) using a knife, screwdriver or similar. Be careful not to scratch the plug.

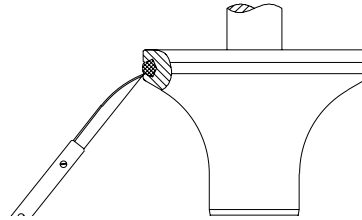

Step 2

Pre-mount seal ring as shown on drawing.

Rotate along circumference to fix gasket as shown in the picture

Carefully lubricate sealings with acceptable soap or lubricant, after pre-mounting.

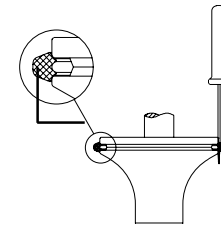

Step 3

Place lower tool part.

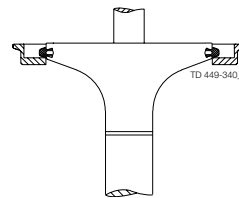

Step 4

1. Place upper tool part including piston.
2. Clamp the two tool parts together.

Tool marked with item number.

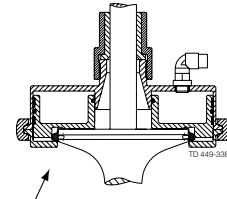

Step 5

1. Supply compressed air.
2. Release compressed air.
3. Remove tool parts.

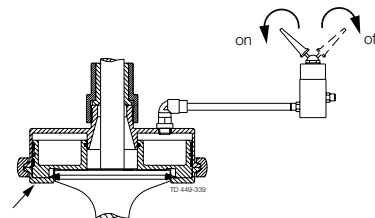

Step 6

Inspect the seal to ensure it does not twist in the groove, and press in the 4 outsticking points with a screwdriver!

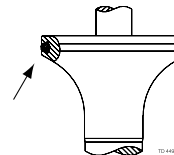

Study the instructions carefully. Handle scrap correctly.

4. Replacement of seal ring, upper plug

Step 1

Remove old seal ring (56) using a knife, screwdriver or similar. Be careful not to scratch the plug.

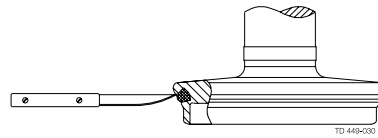

Step 2

Pre-mount seal ring as shown on drawing.

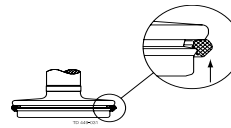

Carefully lubricate sealings with acceptable soap or lubricant, after pre-mounting.

Step 3

Place tool part 1.

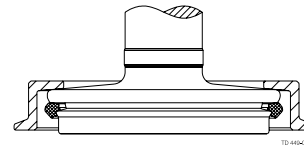

Step 4

1. Place tool part 2 including piston.
2. Clamp the two tool parts together.

Tooling marked with item number

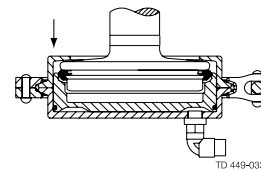

Step 5

1. Supply compressed air.
2. Release compressed air.
3. Rotate the tool 45° with regards to the plug.
4. Supply compressed air.
5. Release compressed air and remove tool.

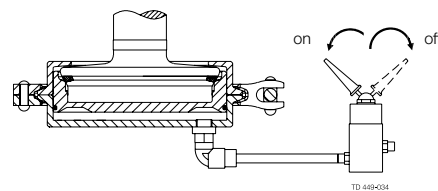

Step 6

1. Inspect the seal.
2. Release air at 3 different positions of the circumference.

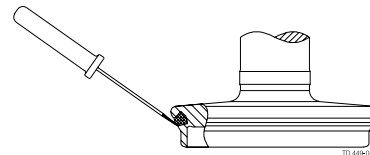

Re-Assemble Valve
(Excluding Actuator)

Note:

- * Lubricate seals with Kluber Paraliq GTE 703 or similar USDA H1 Approved lubricant (#022148-213).
- ** Lubricate threads with Kluber Paste UH1 84-201 or similar.

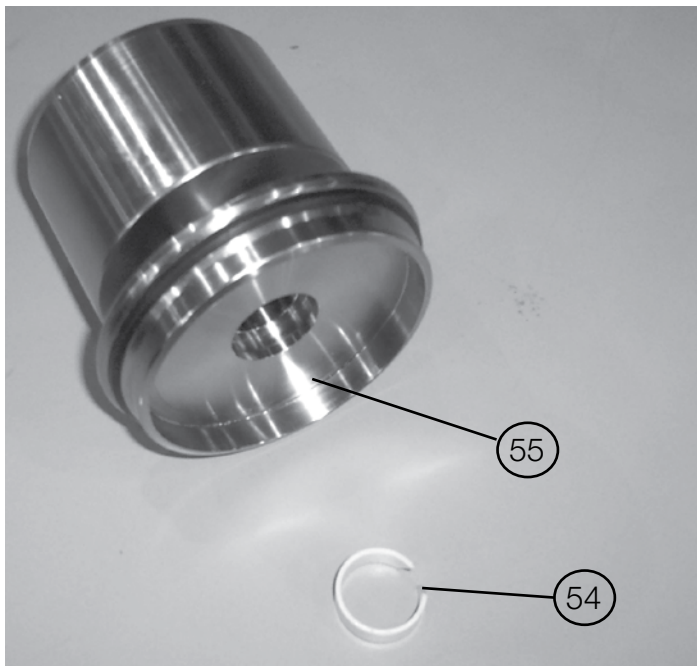

1. Hand clean and sanitize guide ring (54).
2. Hand clean and sanitize ID of upper plug stem (55).

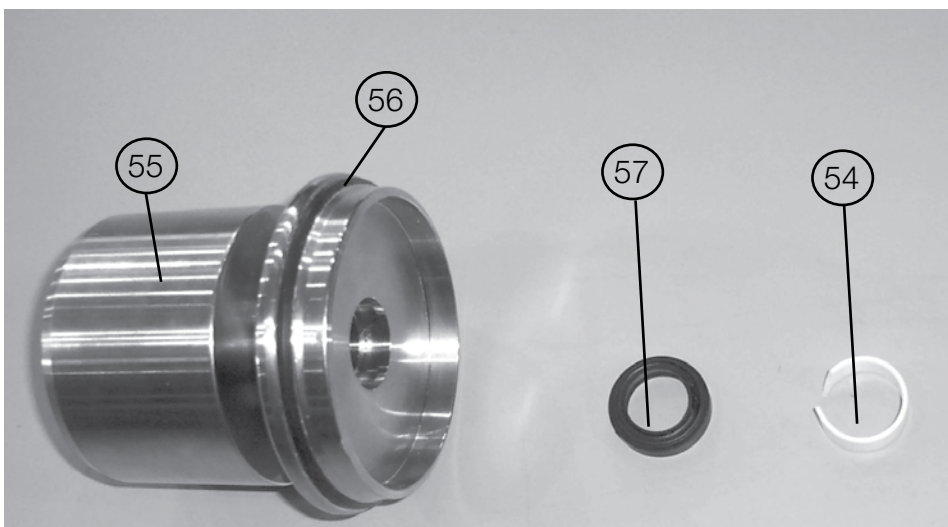

3. Install guide ring (54).
4. Install *lip seal (57).

Re-Assemble Valve
(Excluding Actuator)

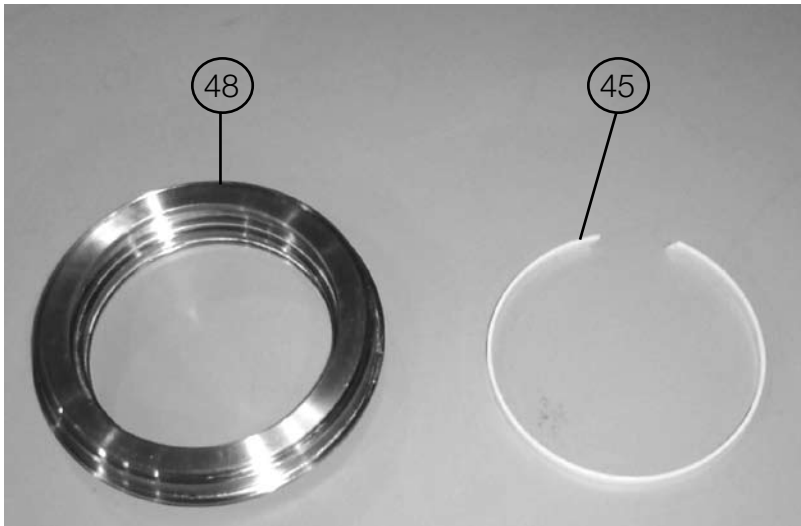

5. Hand clean and sanitize guide ring (45).
6. Hand clean and sanitize upper sealing element (48).
7. Install guide ring (45).

8. Install *lip seal (49).
9. Install *o-ring seal (47).

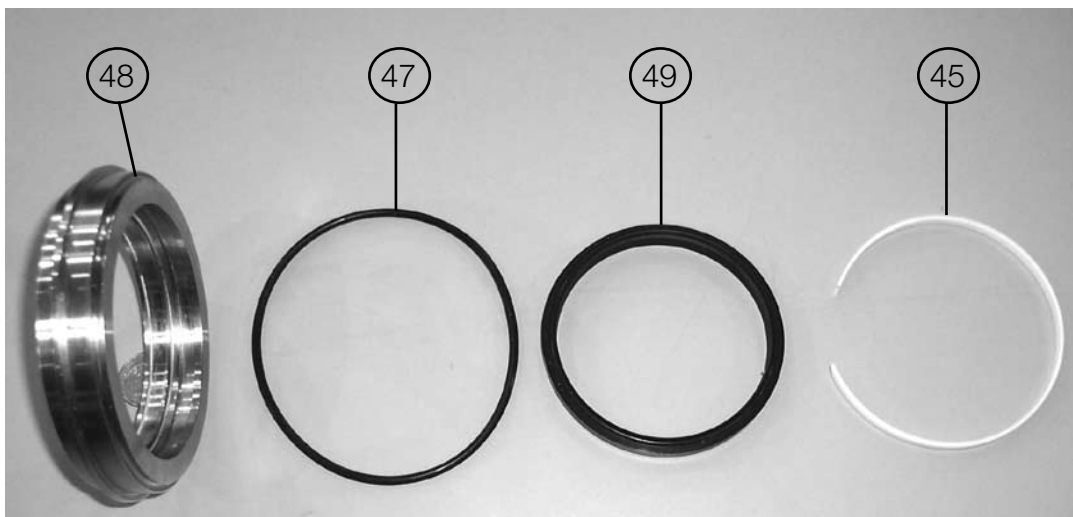

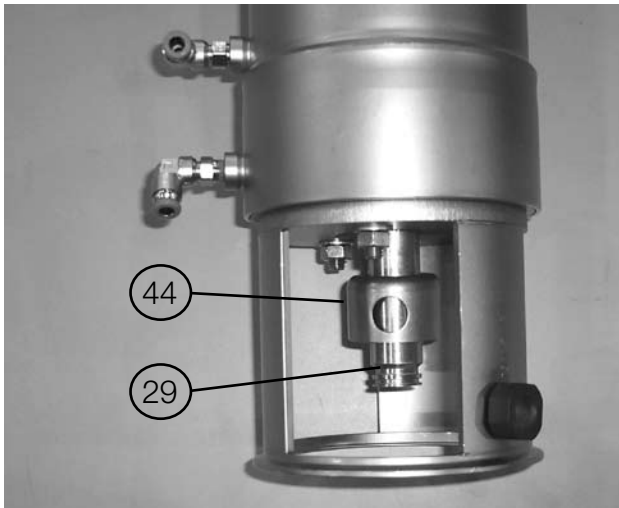

10. Install lock (44) onto piston rod (29).

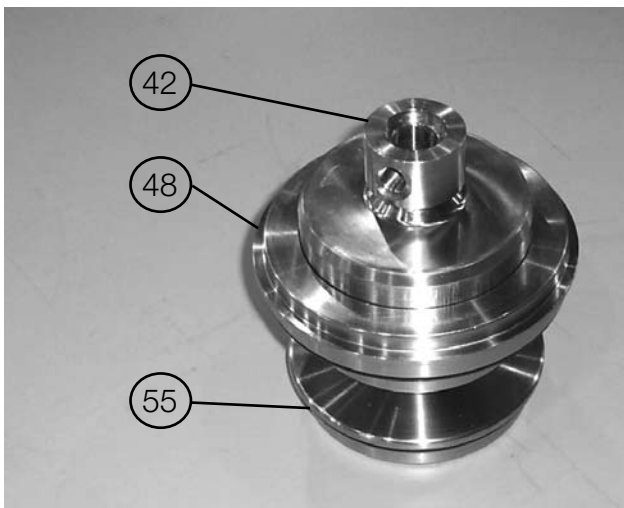

11. Slide upper sealing element (48) onto upper plug (55).

12. Install spindle liner (42) onto upper plug stem (55).

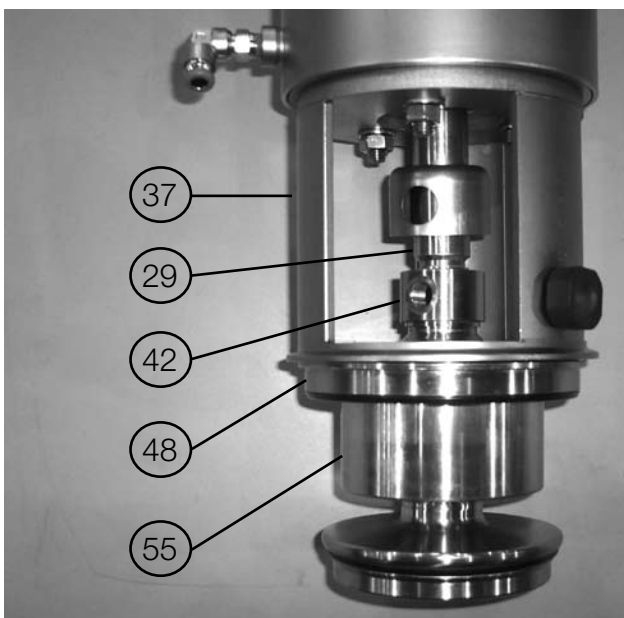

13. Fit upper plug (55), upper sealing element (48) and spindle liner (42) into intermediate piece (37).

14. Push upper plug (55) to fit spindle liner (42) tight against piston rod (29).

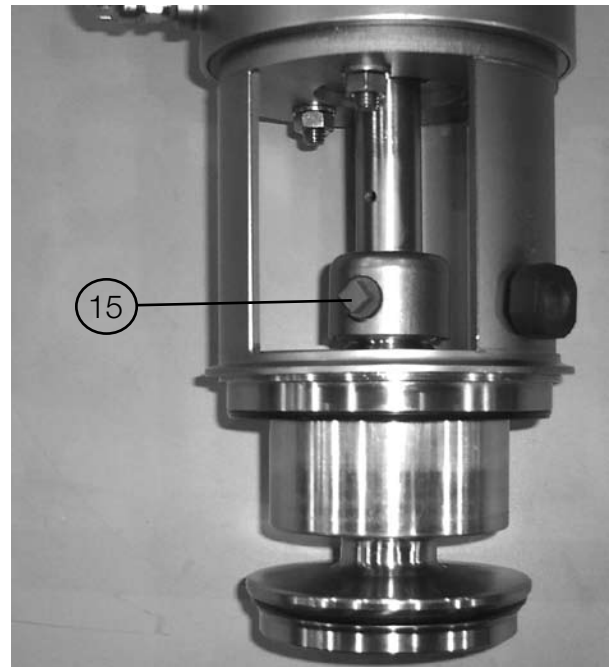
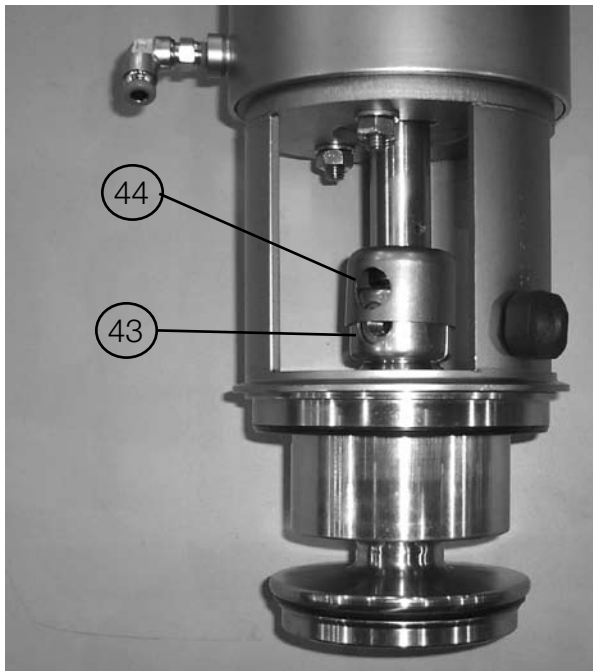

- 15. Install two clamps (43) Note: Align one clamp with female thread in spindle liner (42).
- 16. Slide lock (44) down over clamps (43) Note: Align holes.

- 17. Install plug (15).
- 18. Install *O-ring (38) on lower plug stem (75)

Unique PMO Plus[®]



***Unique PMO Plus[®] - CP**

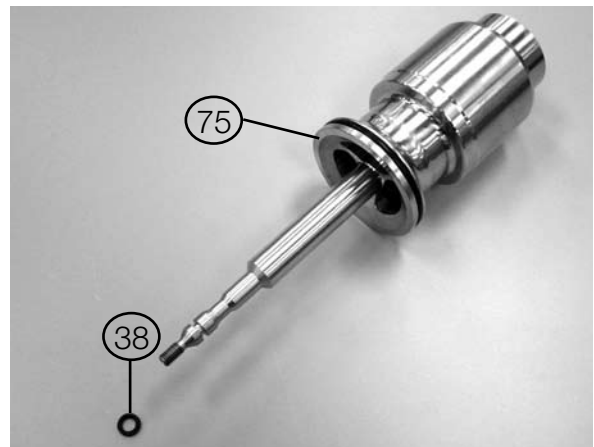

See pages 68 to 73 for part numbers.

Effective 11/1/07, Revised 1/1/09, Revised 8/1/09

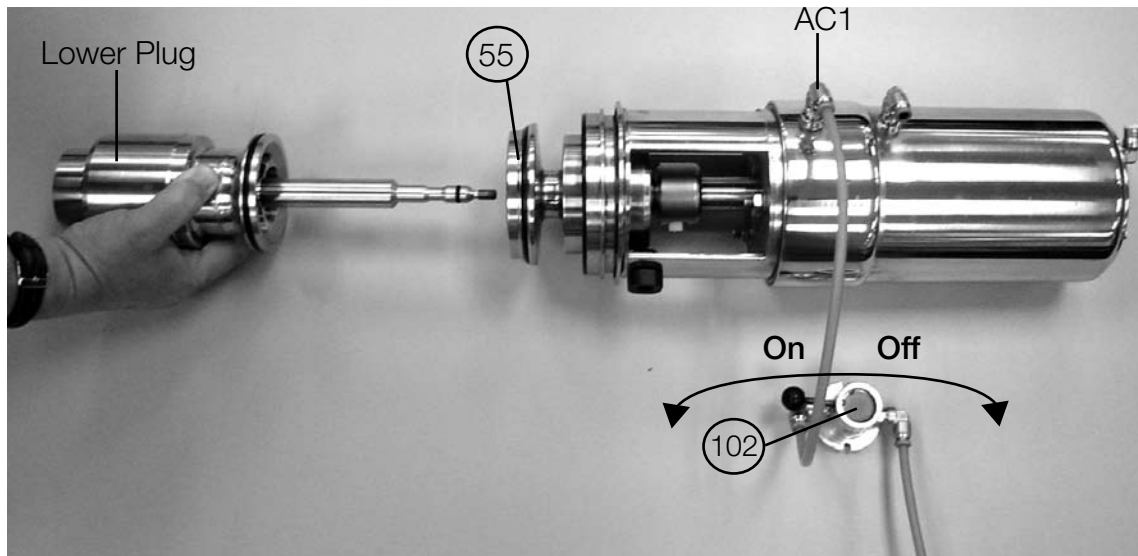

19. Supply compressed air to AC1 (Red Ring).
20. Fit **lower plug stem into ID of upper plug (55) and turn clockwise to tighten by hand.
21. Tighten lower plug clockwise using strap wrench while counter holding upper actuator stem (1) with a 16mm wrench.
22. Release compressed air.

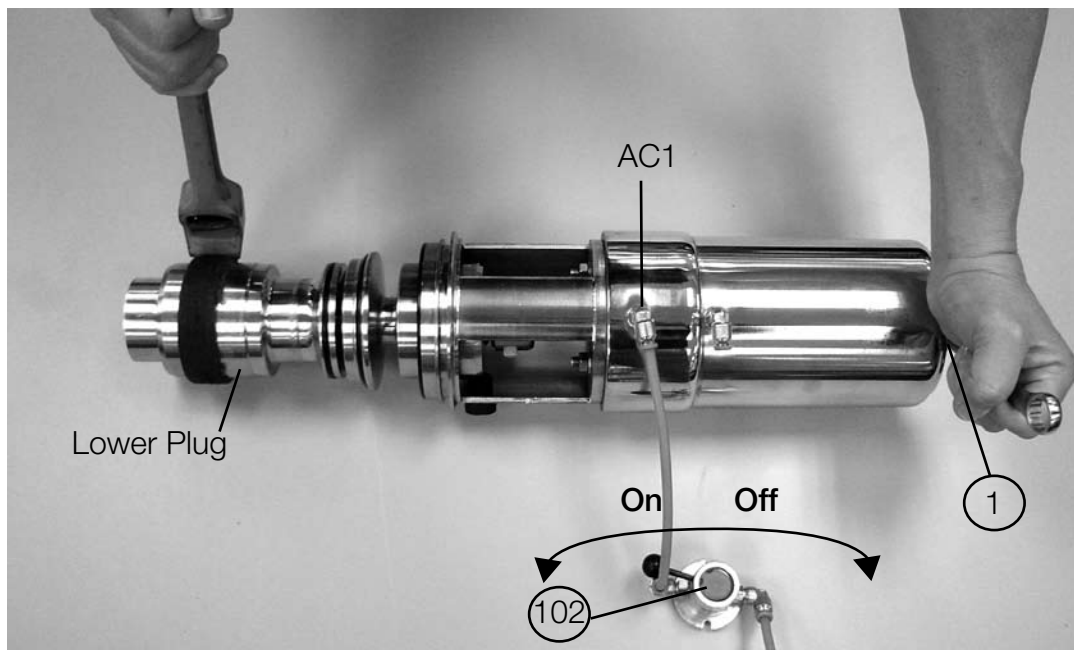

Unique PMO Plus[®]

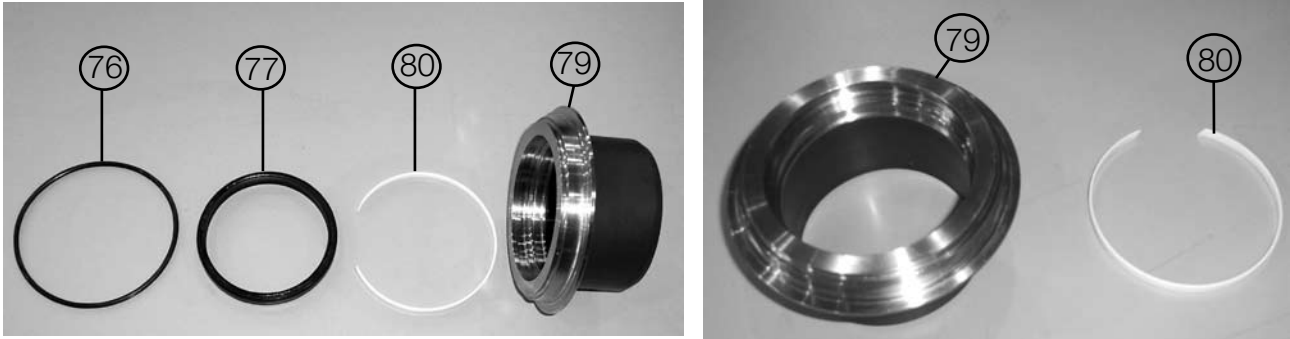

- 23. Hand clean and sanitize guide ring (80).
- 24. Hand clean and sanitize lower sealing element (79).
- 25. Install guide ring (80).
- 26. Install *lip seal (77).
- 27. Install *O-ring (76).

Unique PMO Plus[®] - CP

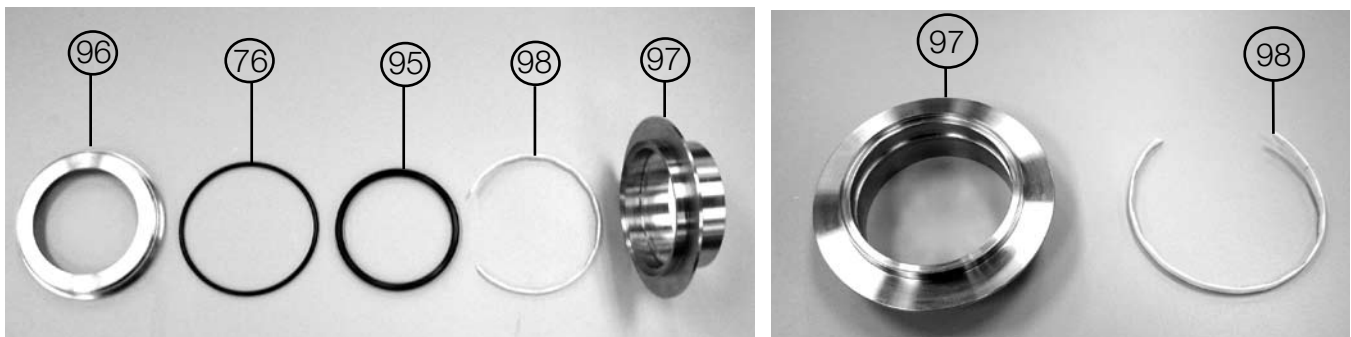

- 23. Hand clean and sanitize guide ring (98).
- 24. Hand clean and sanitize lower element parts (97) and (96).
- 25. Install guide ring (98).
- 26. Install *seal (95).
- 27. Install *O-ring (76).

See pages 68 to 73 for part numbers.

Effective 11/1/07, Revised 1/1/09, Revised 8/1/09

28. Install lower sealing element assembly onto body (50).
29. Fit and tighten lower clamp (64).
30. Supply compressed air to AC2 (Blue Ring).
31. Fit the actuator together with the internal valve parts into the valve body (50).
32. Fit and tighten upper clamp (64).
33. Release compressed air.

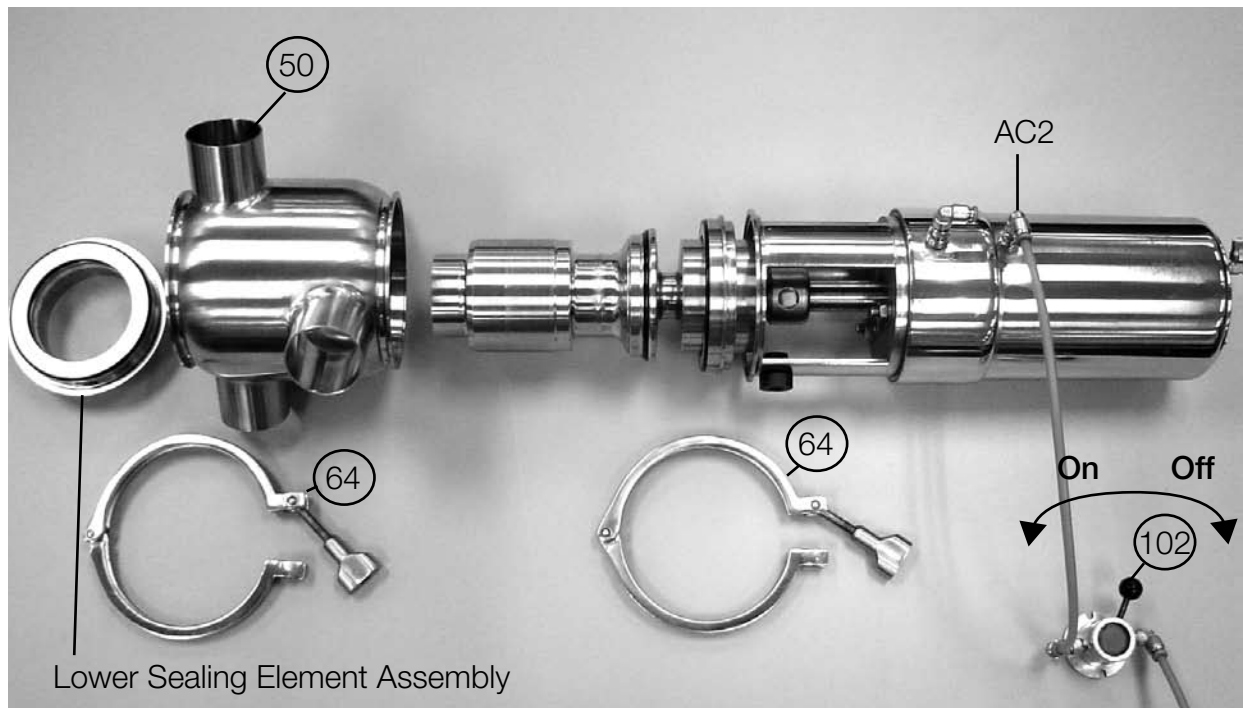

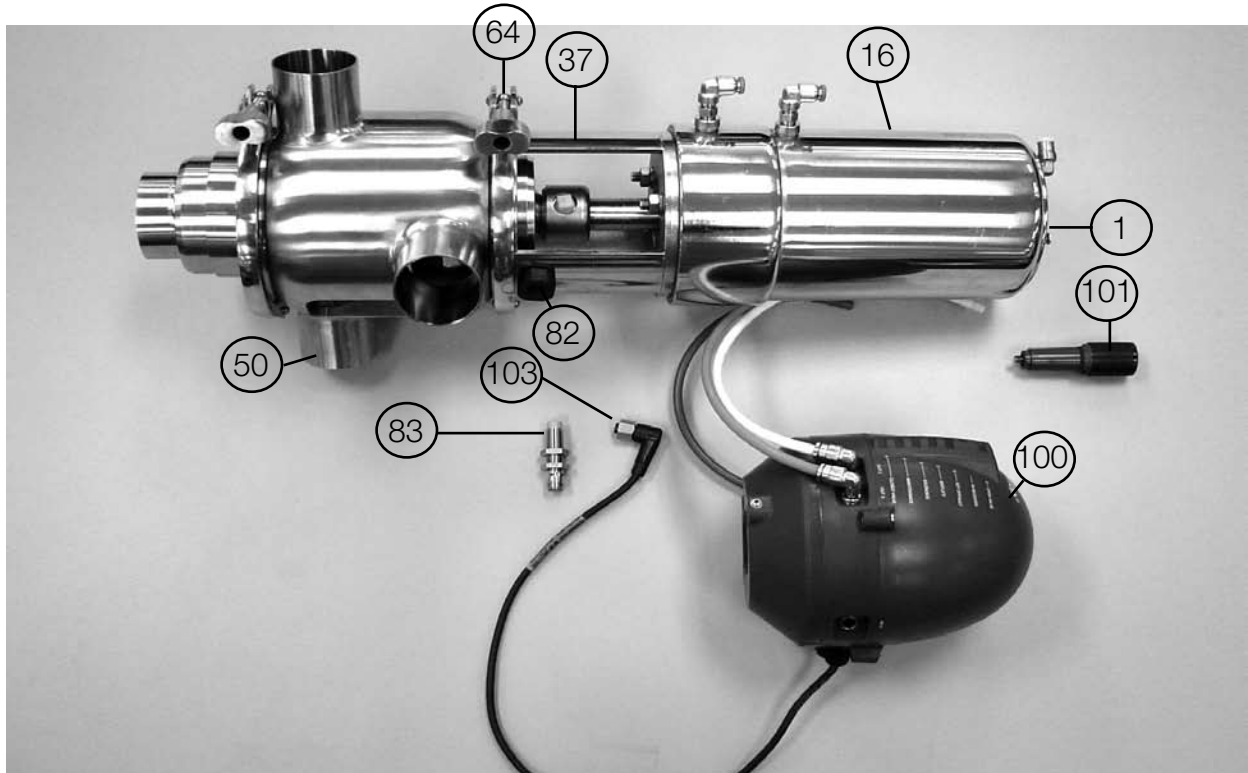

34. Turn sensor (83) clockwise into nylon plug (82) and tighten by hand.
35. Attach sensor cable (103) to sensor (83) and tighten by hand.
36. Turn magnet (101) clockwise into upper actuator stem (1) and tighten by hand.
37. Install *ThinkTop* (100) to cylinder (16).

Dismantling of actuator

1. Remove nuts (36) and washers (35).
2. Pull out intermediate piece (37) from the actuator.
3. Remove cover disk (25).
4. Remove retaining ring (24).
5. Remove piston rod (29), bottom (21) and lower piston (30).
6. Separate the three parts.
7. Remove O-rings (20, 22 and 23) from bottom, O-rings (33 and 31) and guide ring (32) from lower piston as well as O-ring (28) from piston rod.
8. Remove spring assembly (14).
9. Remove inner stem (27), main piston (17) and distance spacer (11) if present. Remove guide ring (18) and O-ring (19).
10. Remove spring assembly (10).

NOTE: 2½", 3", 4" and 6" valves only

1. Unscrew screws (2).
2. Remove stop (4).
3. Remove upper piston (8). Remove O-rings (7 and 9).
4. Remove O-ring (5) and guide ring (6).

Dismantling of actuator

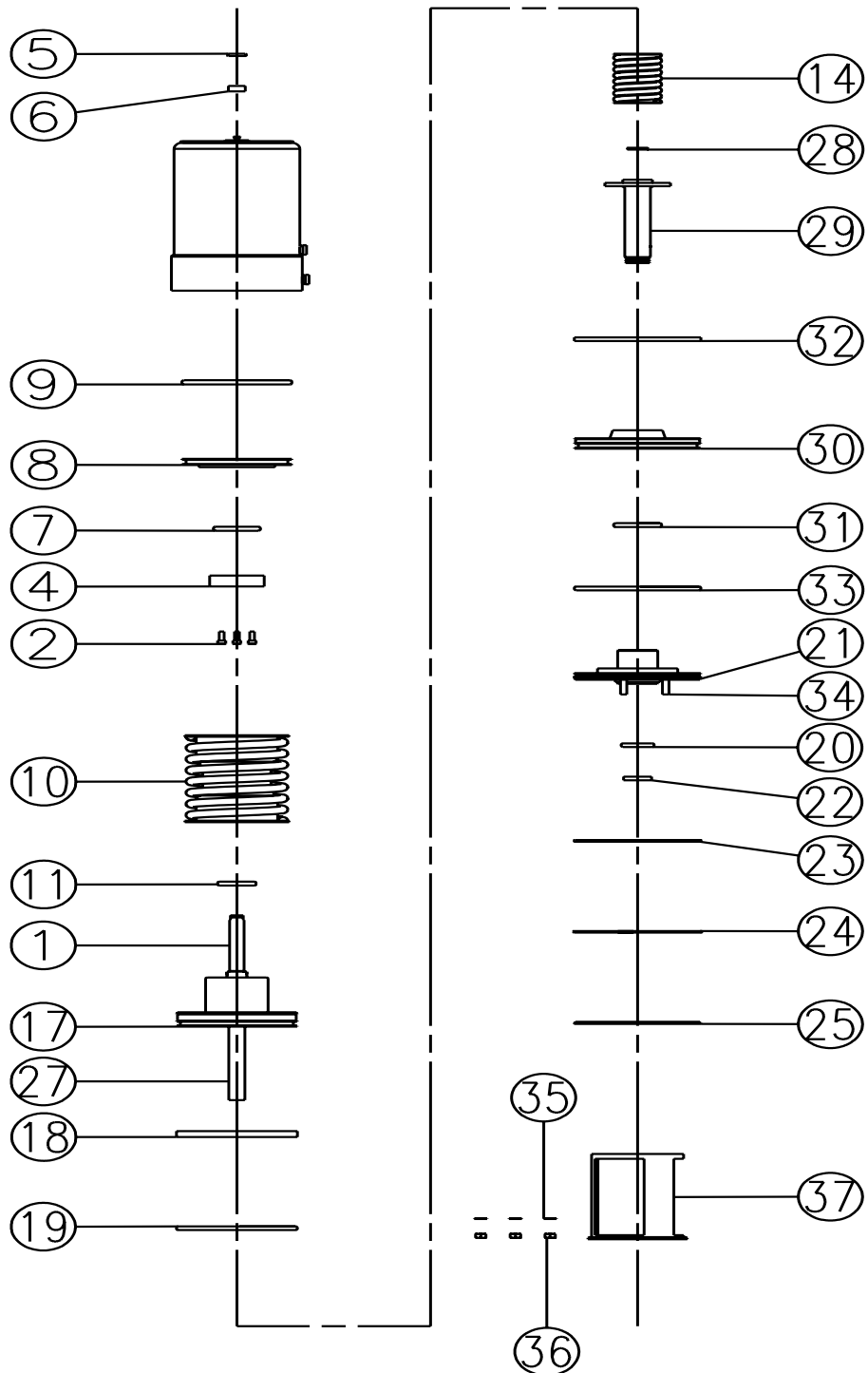

TD 449-068

Reassembly of actuator

1. Fit guide ring (6) and O-ring (5).
NOTE: 2½", 3", 4" and 6" valves only
 2. Fit O-rings (7 and 9). Place upper piston (8).
 3. Fit stop (4).
 4. Tighten screws (2).
2. Place spring assembly (10).
3. Fit O-ring (19) and guide ring (18). Mount distance spacer (11), main piston (17) and inner stem (27).
4. Fit spring assembly (14).
5. Fit O-ring (28) in piston rod, fit O-rings (33 and 31) and guide ring (32) in lower piston and fit O-rings (20, 22 and 23) in bottom.
6. Fit piston rod (29), lower piston (30) and bottom (21).
7. Mount the three parts.
8. Fit retaining ring (24).
9. Fit cover disk (25).
10. Mount intermediate piece (37) on actuator.
11. Fit and tighten nuts (36) and washers (35).

Reassembly of actuator

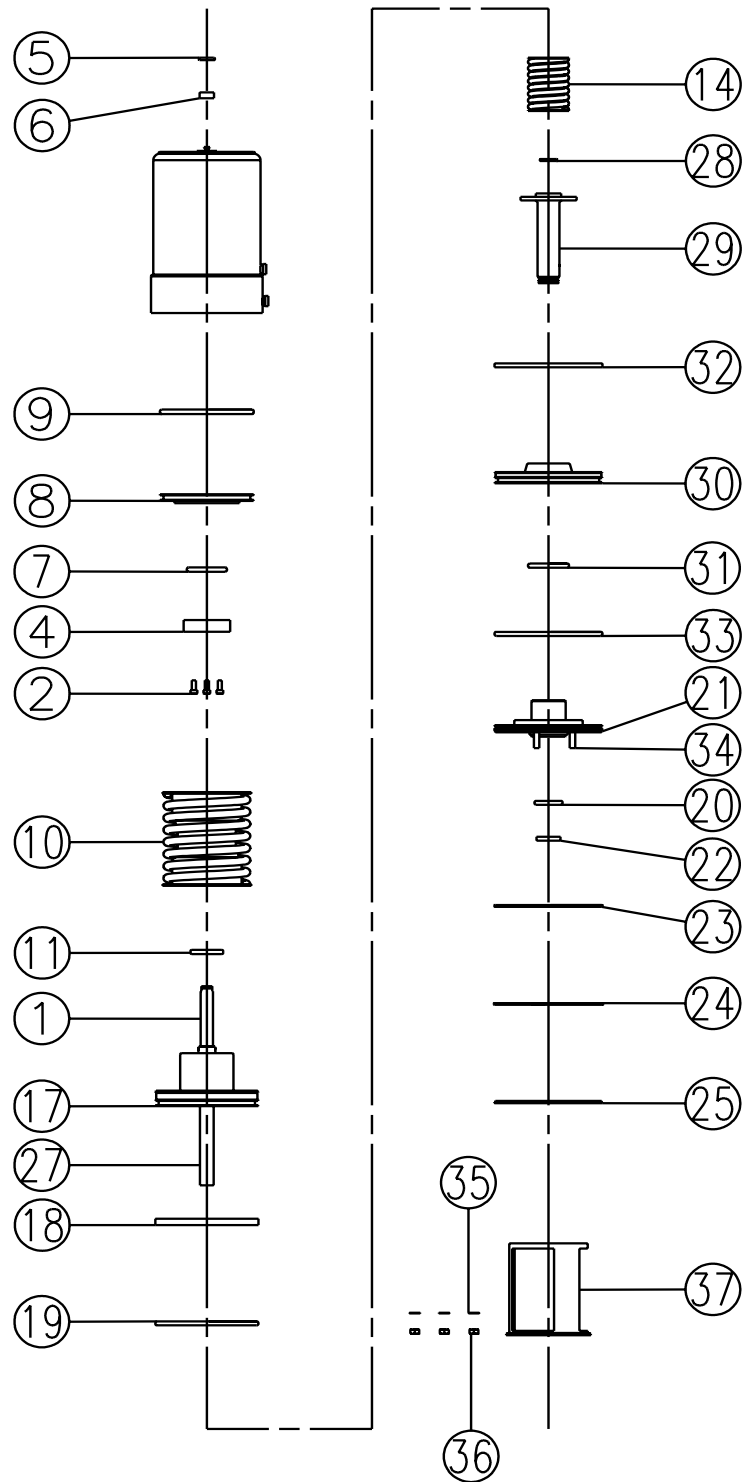

See pages 68 to 73 for part numbers.

Effective 11/1/07, Revised 1/1/09, Revised 8/1/09

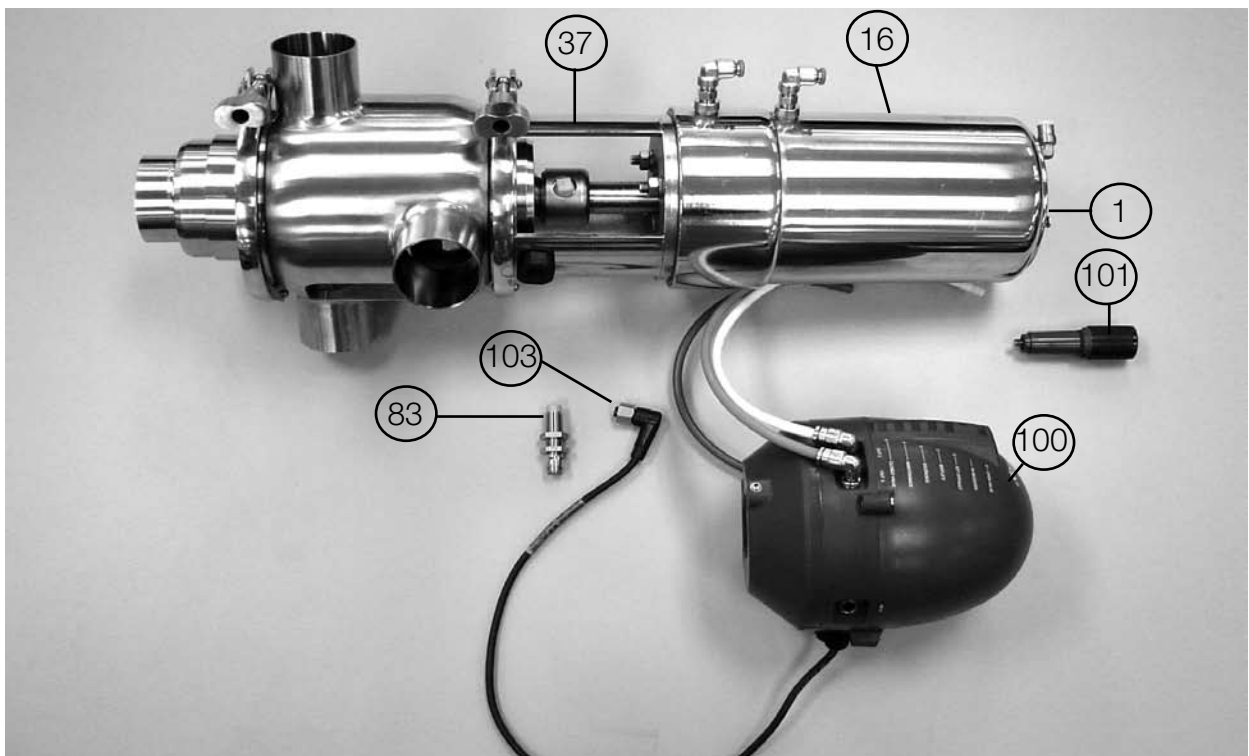
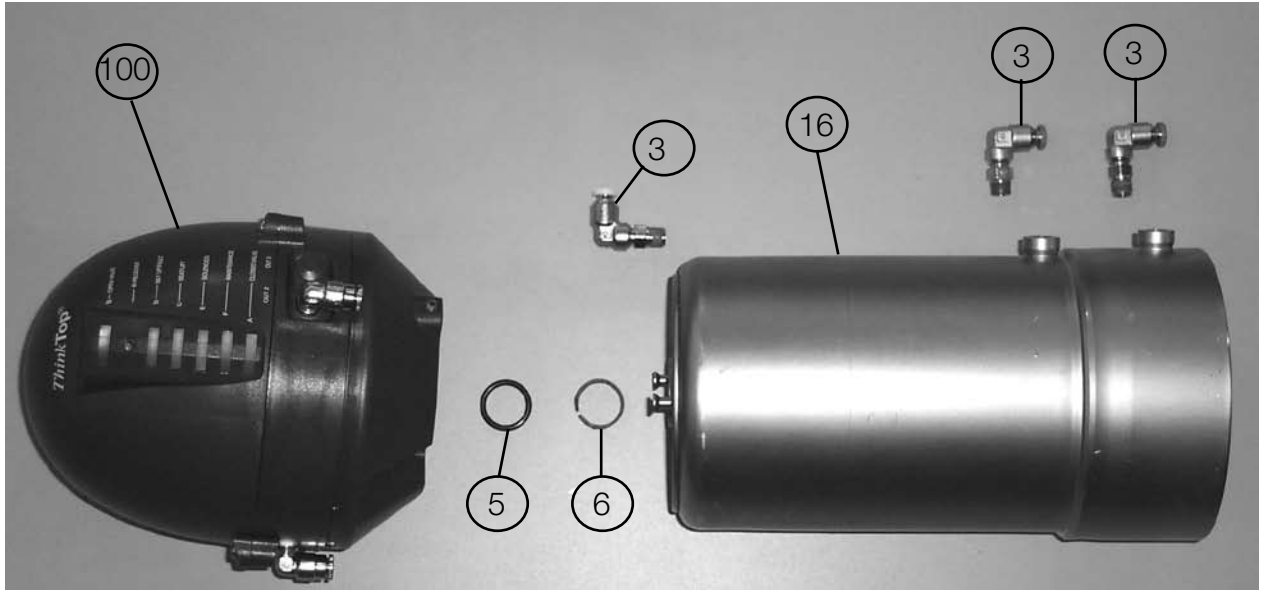

2½", 3" 4" and 6" Sizes only

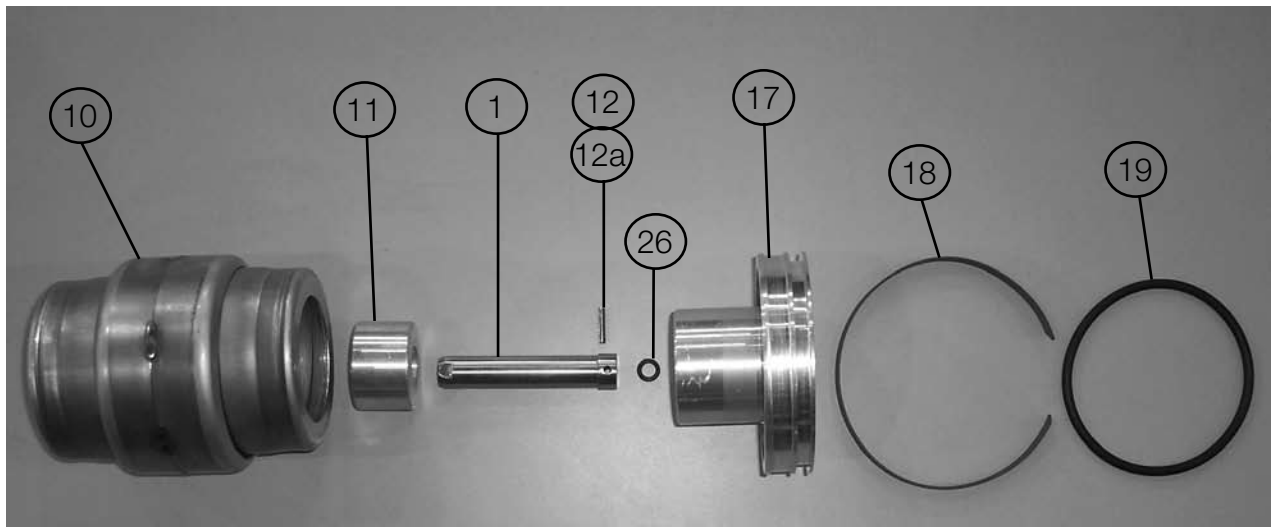
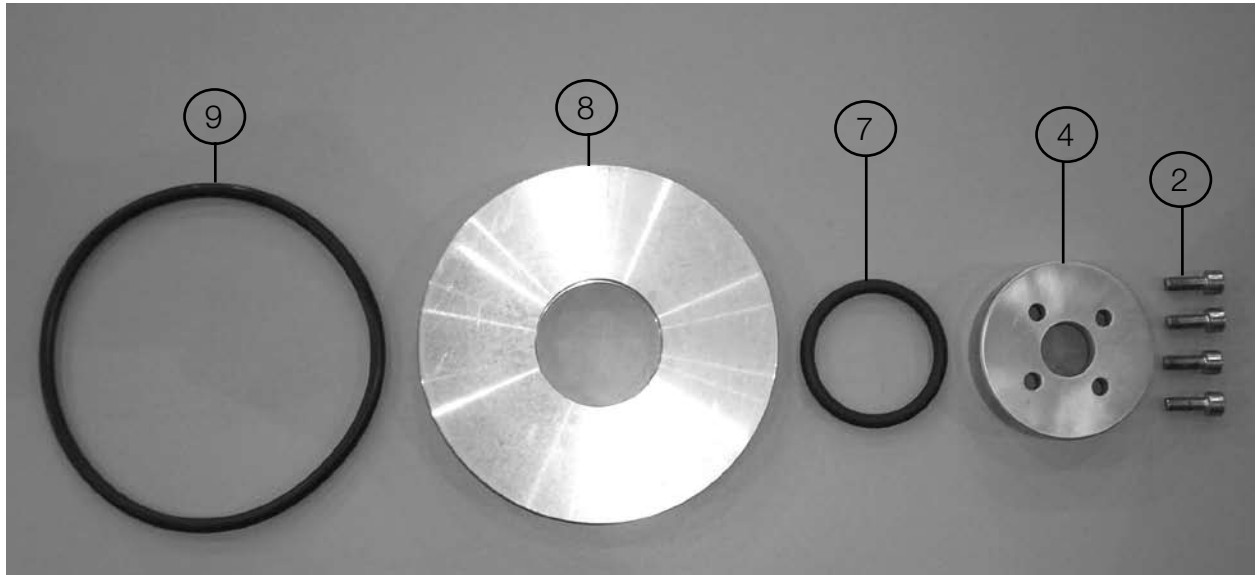

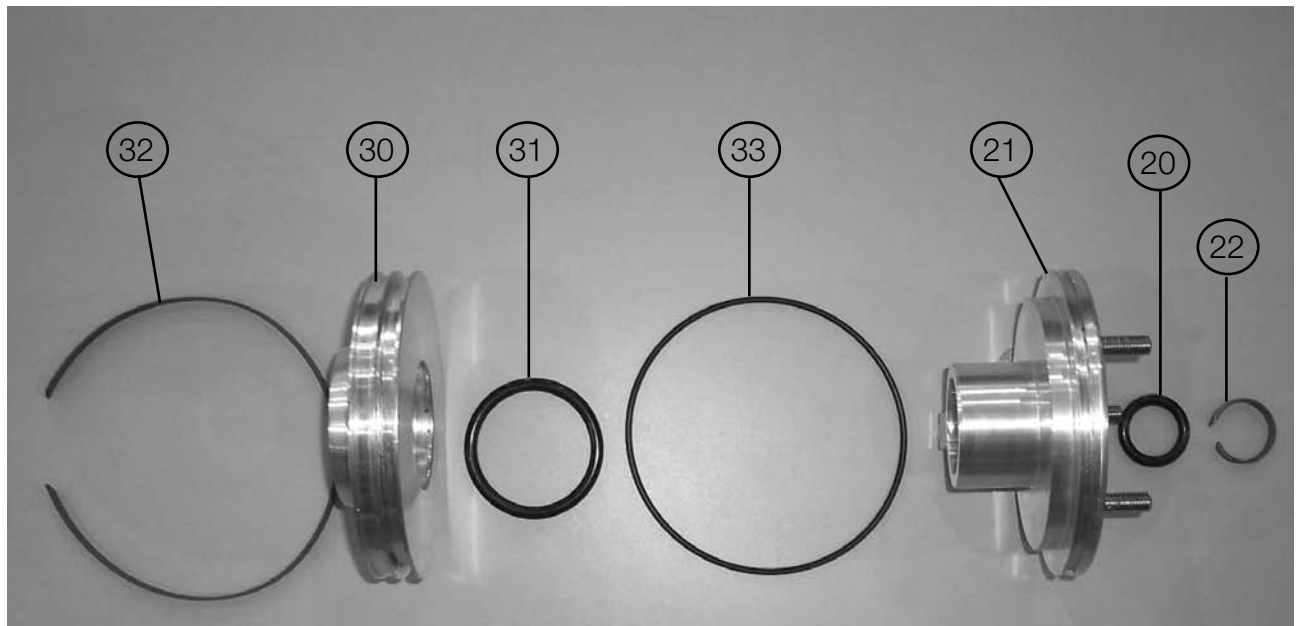
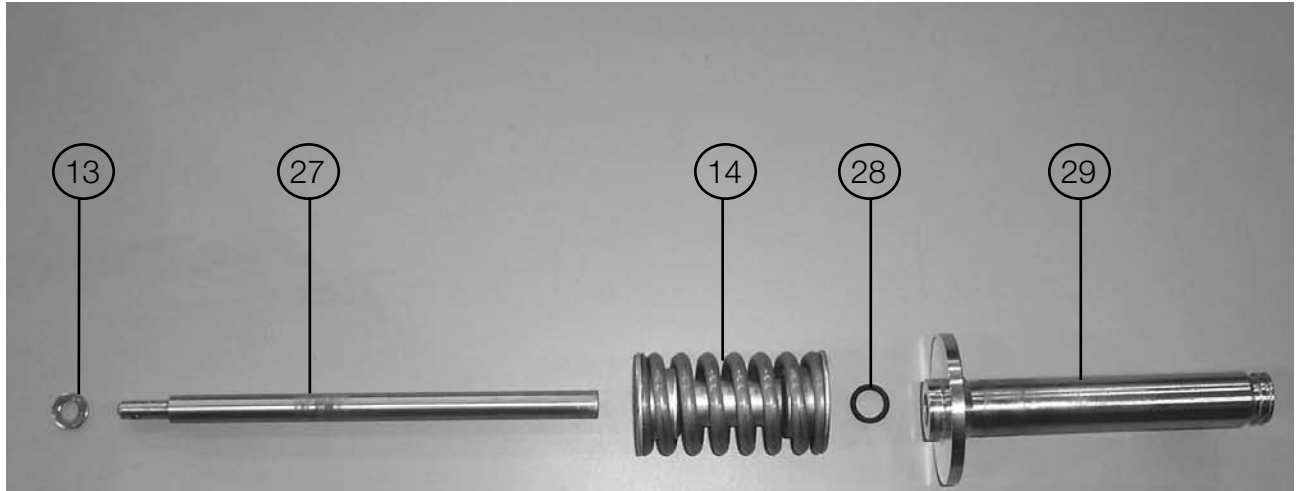

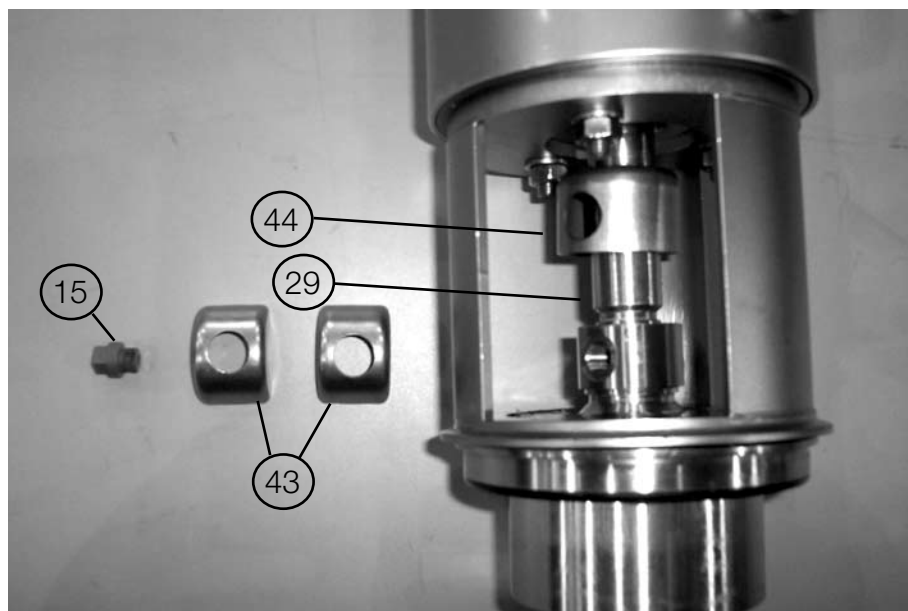
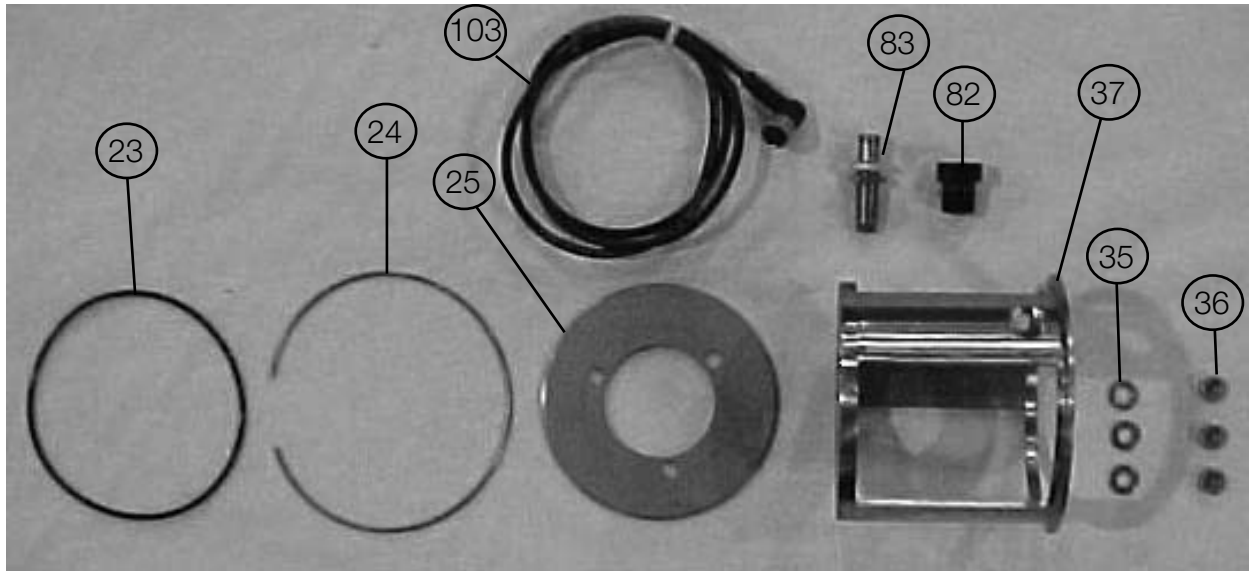

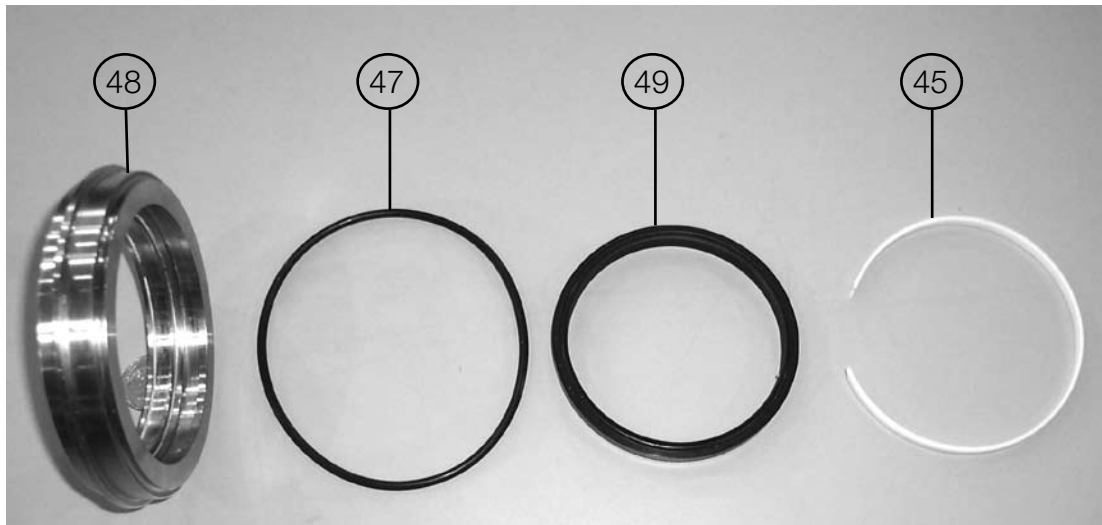
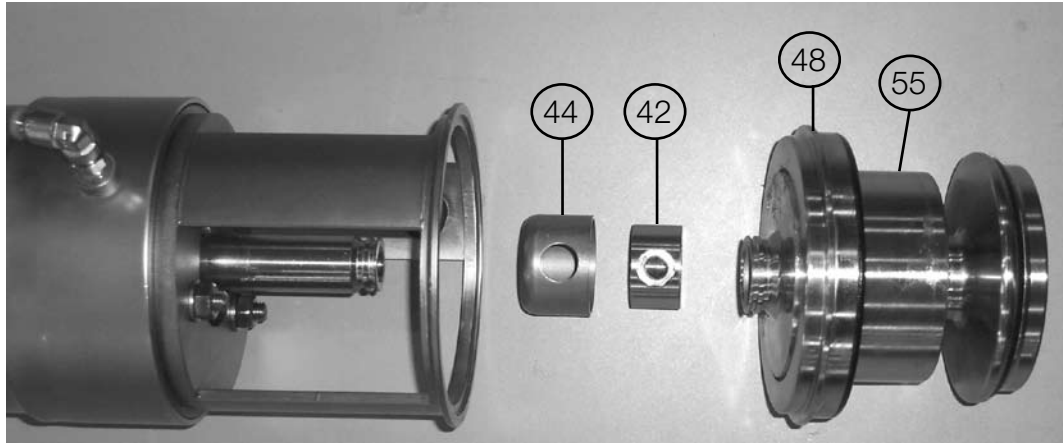

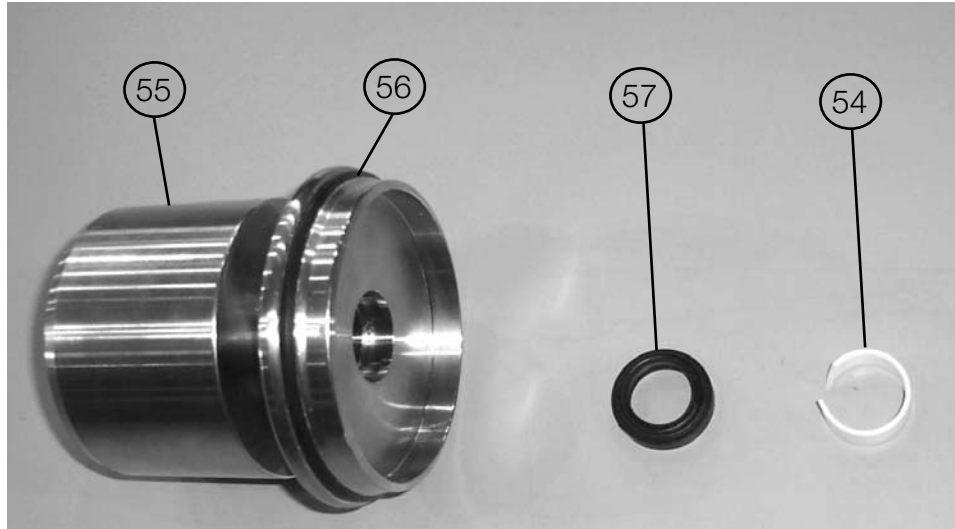

Unique **PMO Plus**[®]

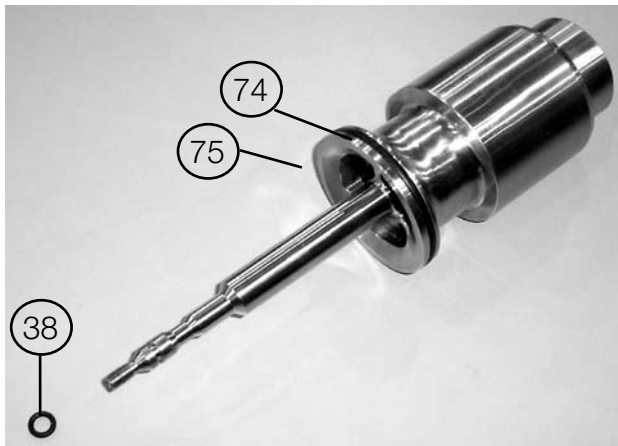

Unique **PMO Plus**[®] - CP

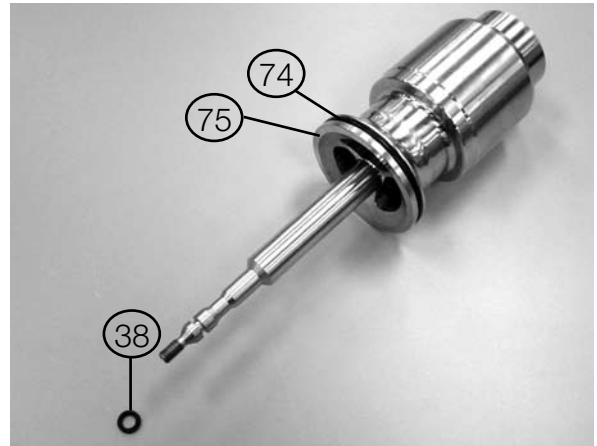

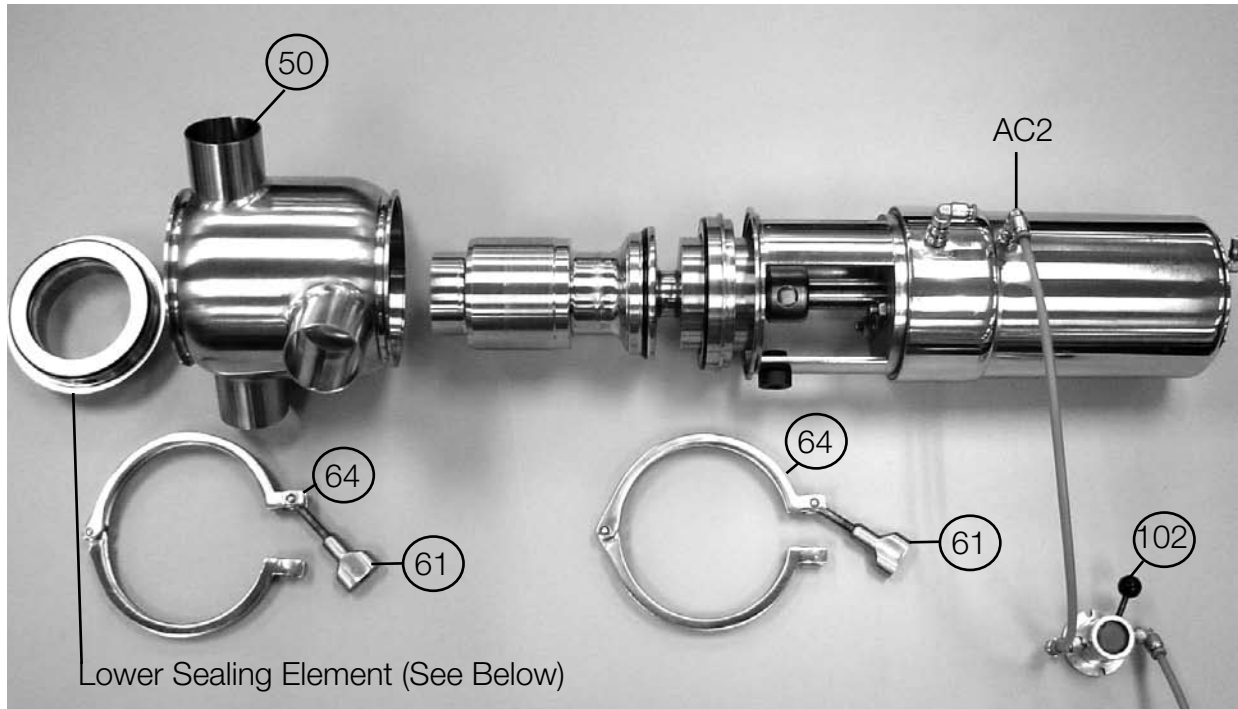

***Unique PMO Plus® - CP**

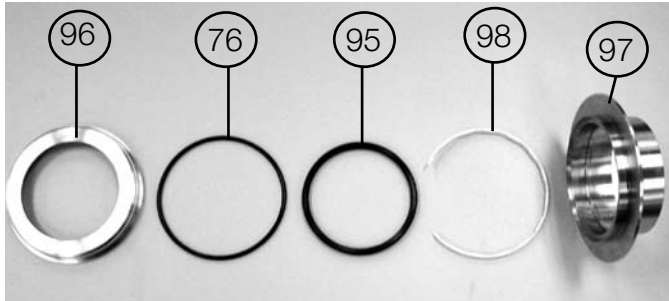

Unique PMO Plus®

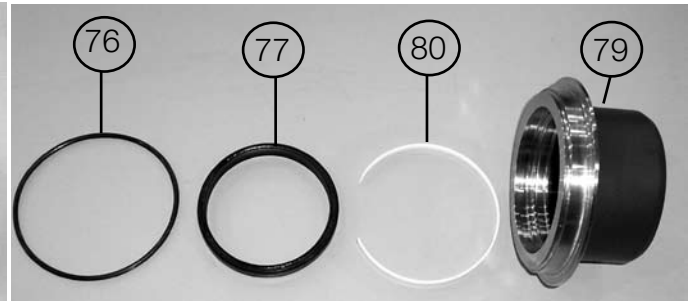

Parts

Pos.	Qty.	Denomination	1½"	2"	2½"	3"	4"	6"
1	1	Upper stem.....	9613-0101-02	9613-0101-02	9613-0074-01	9613-0074-01	9613-0074-02	9613-0074-02
2	4	Screw			9611-99-3342	9611-99-3342	9611-99-3342	9611-99-3342
3	1	Air fitting yellow.....	9611-99-4171	9611-99-4171	9611-99-4171	9611-99-4171	9611-99-4171	9611-99-4171
	1	Air fitting red	9611-99-4172	9611-99-4172	9611-99-4172	9611-99-4172	9611-99-4172	9611-99-3780
	1	Air fitting blue.....	9611-99-3780	9611-99-3780	9611-99-3780	9611-99-3780	9611-99-3780	9611-99-4172
4	1	Stop for upper piston...			9613-0053-01	9613-0053-01	9613-0053-02	9613-4883-01
5	1	O-ring, NBR.....	9611-99-3499	9611-99-3499	9611-99-3499	9611-99-3499	9611-99-3499	9611-99-3499
6	1	Guide ring, Turcite.....	9613-0084-08	9613-0084-08	9613-0084-08	9613-0084-08	9613-0084-08	9613-0084-08
7	1	O-ring, NBR.....			9611-99-3514	9611-99-3514	9611-99-3514	9611-99-3514
8	1	Upper piston.....			9613-0056-01	9613-0056-01	9613-0056-02	9613-0056-02
9	1	O-ring, NBR.....			9611-99-3512	9611-99-3512	9611-99-3513	9611-99-3513
10	1	Spring assembly	9613-0125-01	9613-0125-01	9613-0075-01	9613-0075-01	9613-0256-03	9613-0256-03
11	1	Distance spacer.....	9613-0102-02	9613-0102-02				
12	1	Pin	9611-99-4197	9611-99-4197	9611-99-4198	9611-99-4198	9611-99-4198	9611-99-4199
12a	1	Pin.....			9611-99-3728	9611-99-3728	9611-99-3729	
13	1	Washer	9611-99-3594	9611-99-3594	9611-99-3595	9611-99-3595	9611-99-3596	9611-99-3596
14	1	Spring assembly	9613-0131-01	9613-0131-01	9613-0095-02	9613-0095-02	9613-0095-02	9613-0095-03
15	1	Plug.....	9613-4141-01	9613-0806-01	9613-0806-01	9613-0806-01	9613-0806-01	9613-4141-01
16	1	Cylinder (3A marking)	9613-0126-11	9613-0126-06	9613-0051-06	9613-0051-06	9613-0150-11	9613-0150-18
17	1	Main piston.....	9613-0132-01	9613-0132-01	9613-0057-01	9613-0057-01	9613-0159-01	9613-0159-01
18	1	Guide ring, Turcite.....	9613-0084-09	9613-0084-09	9613-0084-10	9613-0084-10	9613-0084-11	9613-0084-11
19	1	O-ring, NBR.....	9611-99-3505	9611-99-3505	9611-99-3507	9611-99-3507	9611-99-3509	9611-99-3509
20	1	O-ring, NBR.....	9611-99-3503	9611-99-3503	9611-99-3607	9611-99-3607	9611-99-3607	9611-99-3607
21	1	Bottom	9613-0140-01	9613-0140-01	9613-0054-01	9613-0054-01	9613-0168-01	9613-0168-01
22	1	Guide ring, Turcite.....	9613-0084-03	9613-0084-03	9613-0084-04	9613-0084-04	9613-0084-04	9613-0084-04
23	1	O-ring, NBR.....	9611-99-2228	9611-99-3494	9611-99-1489	9611-99-1489	22340675	22340675
24	1	Retaining ring.....	9613-0248-02	9613-0248-02	9613-0248-03	9613-0248-03	9613-0248-04	9613-0248-04
25	1	Cover disk	9613-0058-02	9613-0058-02	9613-0058-03	9613-0058-03	9613-0058-04	9613-0058-04
26	1	O-ring, NBR.....	9611-99-3528	9611-99-3528	9611-99-3495	9611-99-3495	9611-99-1002	9611-99-3530
27	1	Inner stem	9613-0106-03	9613-0106-03	9613-0073-03	9613-0073-03	9613-0073-02	9613-0073-05
28	1	O-ring.....	9611-99-3495	9611-99-3495	9611-99-0030	9611-99-0030	9611-99-0030	9611-99-0030
29	1	Piston rod.....	9613-0134-02	9613-0134-02	9613-0060-02	9613-0060-02	9613-0060-02	9613-0060-04
30	1	Lower piston.....	9613-0138-01	9613-0138-01	9613-0055-01	9613-0055-01	9613-0166-01	9613-0166-01
31	1	O-ring, NBR.....	42153	42153	42153	42153	42153	42153
32	1	Guide ring, Turcite.....	9613-0084-05	9613-0084-05	9613-0084-06	9613-0084-06	9613-0084-07	9613-0084-07
33	1	O-ring, NBR.....	22341275	22341275	9611-99-3508	9611-99-3508	9611-99-3510	9611-99-3510
35	3	Washer	9611-99-3594	9611-99-3594	9611-99-3594	9611-99-3594	9611-99-3594	9611-99-3594
36	3	Nut	9611-99-0360	9611-99-0360	9611-99-0360	9611-99-0360	9611-99-0360	9611-99-0360
42	1	Spindle liner	9613-0335-01	9613-0335-01	9613-0090-01	9613-0090-01	9613-0090-01	9613-0090-01
43	2	Clamp.....	9613-0336-01	9613-0336-01	9613-0092-01	9613-0092-01	9613-0092-01	9613-0092-01
44	1	Lock	9613-0091-02	9613-0091-02	9613-0091-01	9613-0091-01	9613-0091-01	9613-0091-01
45	1	Guide ring, PTFE	9613-0084-13	9613-0084-14	9613-0084-15	9613-0084-15	9613-0084-21	9613-0084-21
48	1	Upper sealing element	9613-4904-01	9613-0064-02	9613-0188-02	9613-0188-02	9613-0713-01	9613-4880-01
54	1	Guide ring, PTFE	9613-0084-01	9613-0084-02	9613-0084-02	9613-0084-02	9613-0084-02	9613-0084-02
55	1	Upper plug	9613-4898-01	9613-4586-01	9613-4587-01	9613-4587-03	9613-4588-01	9613-4863-01
61	2	Wingnut.....	9612-5580-01	9612-5580-01	9612-5580-01	9612-5580-01	9612-5580-01	
64	2	Clamp without nut	9613-0215-01	9613-0216-01	9613-0217-01	9613-0217-01	9613-0218-01	9613-4884-01

Parts

Pos.	Qty.	Denomination	1½"	2"	2½"	3"	4"	6"
37	1	Intermediate piece plug set-up 12	9613-0539-05	9613-0191-21	9613-0192-15	9613-0192-13	9613-0193-17	9613-4859-01
50	1	Valve body 11-00	9613-4892-01	9613-0709-01	9613-0710-01	9613-0711-01	9613-0712-01	9613-4848-01
	1	Valve body 12-00	9613-4892-05	9613-0709-05	9613-0710-05	9613-0711-05	9613-0712-05	9613-4848-05
	1	Valve body 21-00	9613-4892-07	9613-0709-07	9613-0710-07	9613-0711-07	9613-0712-07	9613-4848-07
	1	Valve body 22-00	9613-4892-09	9613-0709-09	9613-0710-09	9613-0711-09	9613-0712-09	9613-4848-09
	1	Valve body 11-90	9613-4892-02	9613-0709-02	9613-0710-02	9613-0711-02	9613-0712-02	9613-4848-02
	1	Valve body 12-90	9613-4892-06	9613-0709-06	9613-0710-06	9613-0711-06	9613-0712-06	9613-4848-06
	1	Valve body 21-90	9613-4892-08	9613-0709-08	9613-0710-08	9613-0711-08	9613-0712-08	9613-4848-08
	1	Valve body 22-90	9613-4892-10	9613-0709-10	9613-0710-10	9613-0711-10	9613-0712-10	9613-4848-10
	1	Valve body 11-180	9613-4892-03	9613-0709-03	9613-0710-03	9613-0711-03	9613-0712-03	9613-4848-03
	1	Valve body 11-270	9613-4892-04	9613-0709-04	9613-0710-04	9613-0711-04	9613-0712-04	9613-4848-04

TYPE 11-00

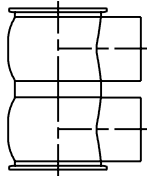

TYPE 11-90

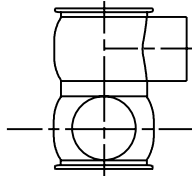

TYPE 11-180

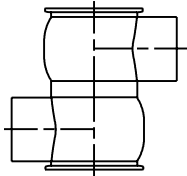

TYPE 11-270

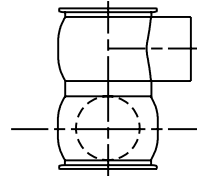

TYPE 12-00

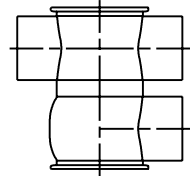

TYPE 12-90

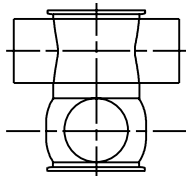

TYPE 21-00

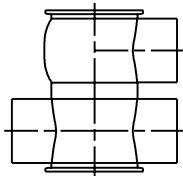

TYPE 21-90

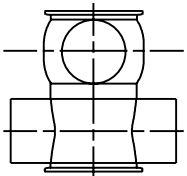

TYPE 22-00

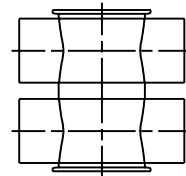

TYPE 22-90

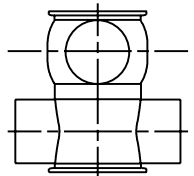

TD 449-014

Pos.	Qty.	Denomination	1½"	2"	2½"	3"	4"	6"
75	1	Lower plug (PMO Plus)	9613-4906-01	9613-0705-01	9613-0706-01	9613-0707-01	9613-0708-01	9613-4965-01
75	1	Lower Plug PMO Plus-CP)	9613-4910-01	9613-4658-01	9613-4658-02	9613-4658-03	9613-4658-04	9613-4871-01
79	1	Lower sealing element (PMO Plus)	9613-4900-01	9613-0241-04	9613-0243-04	9613-0243-04	9613-0715-01	9613-4891-01
80	1	Guide Ring, PTFE (PMO Plus)	9613-0084-27	9613-0084-14	9613-0084-15	9613-0084-15	9613-0084-21	9613-0084-26
81	1	Cover (PMO Plus)	9613-0490-26	9613-0490-06	9613-0490-07	9613-0490-07	9613-0490-16	9613-0490-25
97	1	Lower sealing element, lower part (PMO Plus-CP)	9613-4903-01	9613-4653-01	9613-4655-01	9613-4655-01	9613-4657-02	9613-4882-01
98	1	Guide ring, PTFE (PMO Plus-CP)	9613-4661-07	9613-4661-01	9613-4661-02	9613-4661-02	9613-4661-03	9613-4661-06
96	1	Lower sealing element, upper part (PMO Plus - CP)	9613-4902-01	9613-4652-01	9613-4654-01	9613-4654-01	9613-4656-01	9613-4881-01

Parts

Pos.	Qty.	Denomination	1½"	2"	2½"	3"	4"	6"
100	1	ThinkTop Complete (8-30VDC, 0-Solenoids)	←		9612-5789-01			→
100	1	ThinkTop Complete (8-30VDC, 3-Solenoids)	←		9612-5789-54			→
100	1	ThinkTop Complete (110VAC, 0-Solenoids)	←		9612-9906-01			→
100	1	ThinkTop Complete (110VAC, 3-Solenoids)	←		9612-9906-74			→
101	1	Magnet, ThinkTop	←		9612-5623-01			→
83	1	*Sensor (24VDC)	←		9611-99-4916			→
83	1	**Sensor (110VAC)	←		9613-6036-42			→
82	1	Nylon Plug (24VDC Sensors)	←	9613-0926-02	9613-0926-01			→
82	1	Nylon Plug (110VAC Sensors)	←	9613-6036-38	9613-6036-39			→
103	1	Cable (ext. sensor, 24VDC)	←		9611-99-4913			→
103	1	Cable (ext. sensor, 110VAC)	←		9613-6036-43			→
Optional:								
Pos	Qty.	Denomination						
102	1	Air Pilot Switch	←		9613-6018-13			→

*Sensor Used: IFM IFB3007-APKG/M/V4A/US-102-DPO (3-wire, PNP, DC, N.C., Micro-disconnect)

**Sensor Used: Turck BI4-S12-RDZ32X-0.2M-SBV3T/S1023 (2-wire, PNP, AC, N.C., Micro-disconnect)

Wear Parts

Pos.	Qty.	Denomination	1½"	2"	2½"	3"	4"	6"
38	1	O-ring, EPDM	9611-99-3555	9611-99-3555	9611-99-3572	9611-99-3572	9611-99-3572	9611-99-3572
47	1	O-ring, NBR	9611-99-3633	9611-99-3637	9611-99-3641	9611-99-3641	9611-99-3645	9611-99-5004
	1	O-ring, EPDM	9611-99-3632	9611-99-3636	9611-99-3640	9611-99-3640	9611-99-3644	9611-99-5003
	1	O-ring, FPM	9611-99-3634	9611-99-3638	9611-99-3642	9611-99-3642	9611-99-3646	9611-99-5005
	1	O-ring, HNBR	9611-99-3635	9611-99-3639	9611-99-3643	9611-99-3643	9611-99-3647	9611-99-5006
49	1	Lip seal, NBR	9613-0085-22	9613-0085-46	9613-0085-47	9613-0085-47	9613-0085-37	9613-0085-65
	1	Lip seal, EPDM	9613-0085-21	9613-0085-26	9613-0085-31	9613-0085-31	9613-0085-36	9613-0085-60
	1	Lip seal, FPM	9613-0085-23	9613-0085-28	9613-0085-33	9613-0085-33	9613-0085-38	9613-0085-62
	1	Lip seal; HNBR	9613-0085-24	9613-0085-29	9613-0085-34	9613-0085-34	9613-0085-39	9613-0085-63
56	1	Seal ring, NBR	9613-0951-14	9613-0951-15	9613-0951-16	9613-0951-16	9613-0951-24	9613-0951-48
	1	Seal ring, EPDM	9613-0951-06	9613-0953-09	9613-0953-12	9613-0953-12	9613-0953-19	9613-0951-47
	1	Seal ring, FPM	9613-0951-05	9613-0951-08	9613-0951-11	9613-0951-11	9613-0951-22	9613-0951-46
	1	Seal ring; HNBR	9613-0951-04	9613-0953-08	9613-0953-11	9613-0953-11	9613-0953-18	9613-0951-45
57	1	Lip seal, NBR	9613-0087-17	9613-0087-18	9613-0087-18	9613-0087-18	9613-0087-18	9613-0087-18
	1	Lip seal, EPDM	9613-0087-06	9613-0087-11	9613-0087-11	9613-0087-11	9613-0087-11	9613-0087-11
	1	Lip seal, FPM	9613-0087-08	9613-0087-13	9613-0087-13	9613-0087-13	9613-0087-13	9613-0087-13
	1	Lip seal; HNBR	9613-0087-09	9613-0087-14	9613-0087-14	9613-0087-14	9613-0087-14	9613-0087-14
74	1	Seal ring; NBR	9613-0952-14	9613-0952-15	9613-0952-16	9613-0952-16	9613-0952-24	9613-0952-48
	1	Seal ring; EPDM	9613-0952-06	9613-0089-09	9613-0089-12	9613-0089-12	9613-0089-18	9613-0952-47
	1	Seal ring; FPM	9613-0952-05	9613-0952-08	9613-0952-11	9613-0952-11	9613-0952-22	9613-0592-46
	1	Seal ring; HNBR	9613-0952-04	9613-0089-08	9613-0089-11	9613-0089-11	9613-0089-17	9613-0952-45
76	1	O-ring, NBR	9611-99-3633	9611-99-3637	9611-99-3641	9611-99-3641	9611-99-3645	9611-99-5004
	1	O-ring, EPDM	9611-99-3632	9611-99-3636	9611-99-3640	9611-99-3640	9611-99-3644	9611-99-5003
	1	O-ring, FPM	9611-99-3634	9611-99-3638	9611-99-3642	9611-99-3642	9611-99-3646	9611-99-5005
	1	O-ring, HNBR	9611-99-3635	9611-99-3639	9611-99-3643	9611-99-3643	9611-99-3647	9611-99-5006
77	1	Lip seal, NBR (PMO Plus)	9613-0085-59	9613-0085-46	9613-0085-47	9613-0085-47	9613-0085-37	9613-0085-65
	1	Lip seal, EPDM (PMO Plus)	9613-0085-54	9613-0085-26	9613-0085-31	9613-0085-31	9613-0085-36	9613-0085-60
	1	Lip seal, FPM (PMO Plus)	9613-0085-56	9613-0085-28	9613-0085-33	9613-0085-33	9613-0085-38	9613-0085-62
	1	Lip seal; HNBR (PMO Plus)	9613-0085-57	9613-0085-29	9613-0085-34	9613-0085-34	9613-0085-39	9613-0085-63
95	1	Seal, NBR (PMO Plus-CP)	9613-4642-44	9613-4642-04	9613-4642-08	9613-4642-08	9613-4642-12	9613-4642-48
	1	Seal, EPDM (PMO Plus-CP)	9613-4642-43	9613-4642-03	9613-4642-07	9613-4642-07	9613-4642-11	9613-4642-47
	1	Seal, FPM (PMO Plus-CP)	9613-4642-42	9613-4642-02	9613-4642-06	9613-4642-06	9613-4642-10	9613-4642-46
	1	Seal; HNBR (PMO Plus-CP)	9613-4642-41	9613-4642-01	9613-4642-05	9613-4642-05	9613-4642-09	9613-4642-45

Service Kit for Product Wetted Parts (PMO Plus)

Denomination	1½"	2"	2½" and 3"	4"	6"
NBR	9611-92-6845	9611-92-6016	9611-92-6017	9611-92-6018	9611-92-6849
EPDM	9611-92-6846	9611-92-6013	9611-92-6014	9611-92-6015	9611-92-6850
FPM	9611-92-6848	9611-92-6019	9611-92-6020	9611-92-6021	9611-92-6852
HNBR	9611-92-6847	9611-92-6022	9611-92-6023	9611-92-6024	9611-92-6851

Service Kit for Product Wetted Parts (PMO Plus-CP)

Denomination	1½"	2"	2½" and 3"	4"	6"
NBR	9611-92-6853	9611-92-6830	9611-92-6831	9611-92-6832	9611-92-6857
EPDM	9611-92-6854	9611-92-6827	9611-92-6828	9611-92-6829	9611-92-6858
FPM	9611-92-6856	9611-92-6833	9611-92-6834	9611-92-6835	9611-92-6860
HNBR	9611-92-6855	9611-92-6836	9611-92-6837	9611-92-6838	9611-92-6859

Conversion Kit for PMO Plus[®] to PMO Plus-CP[®] Upgrade

Denomination	1½"	2"	2½"	3"	4"	6"
NBR	9613-4662-73	9613-4662-17	9613-4662-18	9613-4662-19	9613-4662-20	9613-4662-74
EPDM	9613-4662-75	9613-4662-21	9613-4662-22	9613-4662-23	9613-4662-24	9613-4662-76
FPM	9613-4662-79	9613-4662-29	9613-4662-30	9613-4662-31	9613-4662-32	9613-4662-80
HNBR	9613-4662-77	9613-4662-25	9613-4662-26	9613-4662-27	9613-4662-28	9613-4662-78

Axial Installation Tool

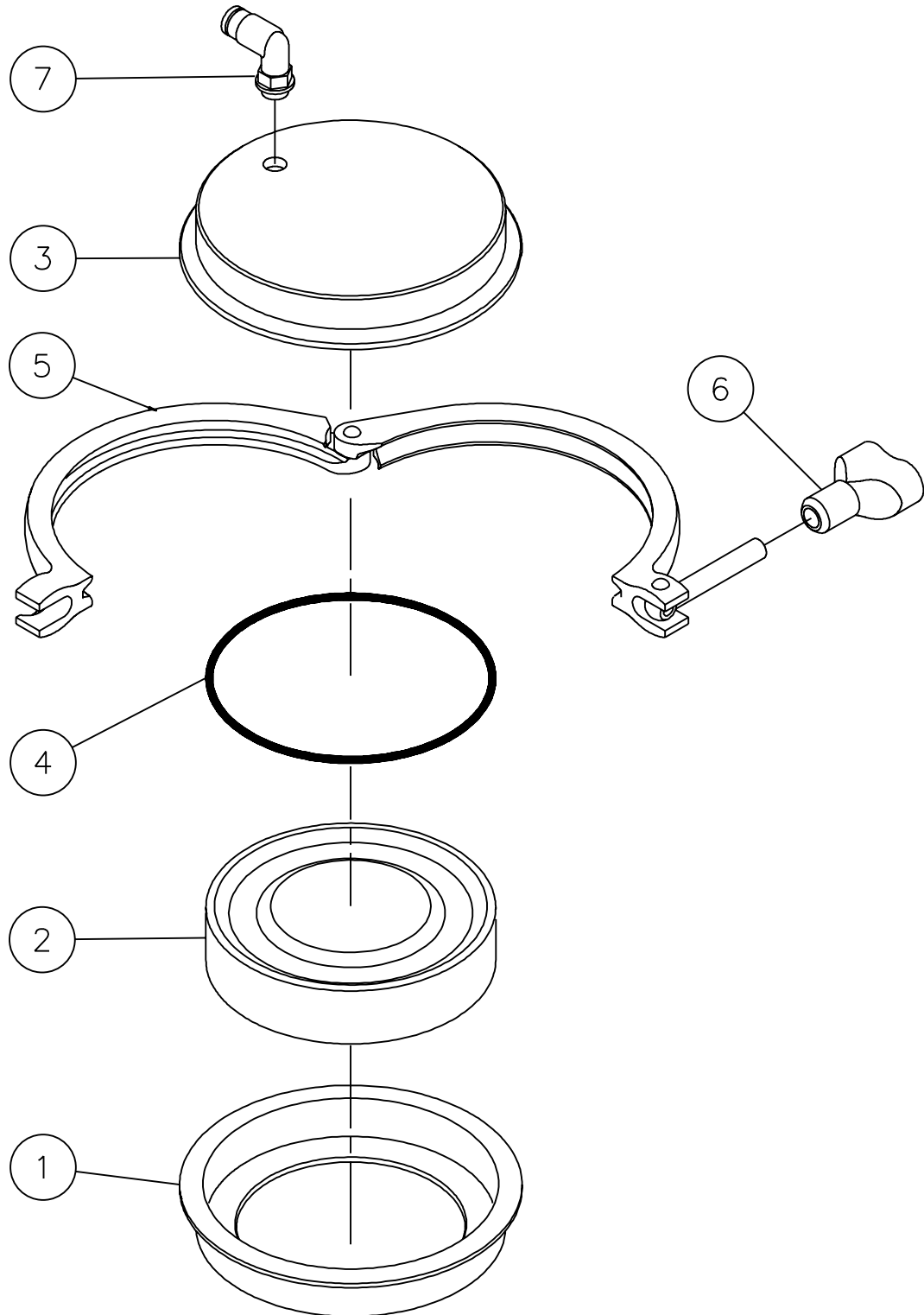

Axial Installation Tool

Pos.	Qty.	Denomination	1½"	2"	2½" and 3"	4"	6"
			9613-0505-01	9613-0505-02	9613-0505-03	9613-0505-07	9613-0505-10
1	1	Lower part		9613-0506-01	9613-0509-01	9613-0722-01	
2	1	Piston		9613-0508-01	9613-0511-01	9613-0721-01	
3	1	Upper part		9613-0503-01	9613-0510-01	9613-0720-01	
4	1	O-ring, NBR	9611-99-3703	9611-99-3703	9611-99-3349	9611-99-4113	9613-4260-10
5	1	Clamp		9613-0216-01	9613-0217-01	9613-0218-01	
6	1	Wingnut		9612-5580-01	9612-5580-01	9612-5580-01	
7	1	Air fitting		9611-99-1988	9611-99-1988	9611-99-1988	

Radial Installation Tool

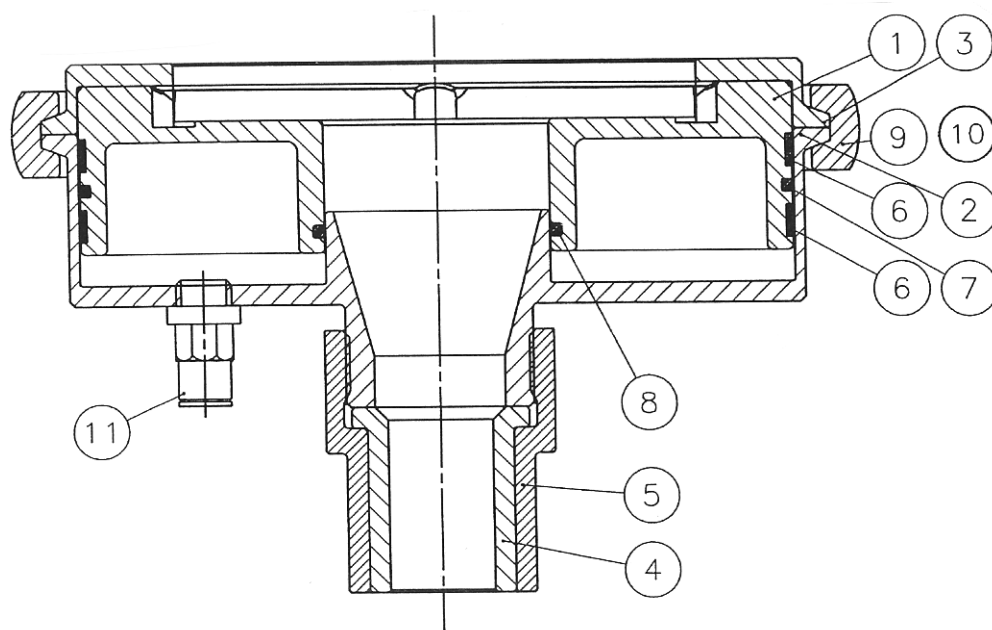

Radial Installation Tool

Pos.	Qty.	Denomination	1½"	2"	2½" and 3"	4"	6"
			9613-4260-01	9613-4260-02	9613-4260-04	9613-4260-09	9613-4260-10
1	1	Piston		9613-4259-02	9613-4259-04	4613-4259-05	
2	1	Lower Part		9613-4258-01	9613-4258-01	9613-4258-02	
3	1	Upper part		9613-0037-02	9613-0037-04	9613-0037-05	
4	1	Bushing		9613-0036-02	9613-0036-02	9613-4257-01	
5	1	Guide		9613-4257-01	9613-4257-01	9613-4257-01	
6	2	Guide Ring	9613-0084-22	9613-0084-22	9613-0084-22	9613-0084-23	9613-0084-24
7	1	O-Ring	9611-99-3349	9611-99-3349	9611-99-3349	9611-99-4113	9613-0505-10
8	1	O-Ring	9611-99-3705	9611-99-3705	9611-99-3705	9611-99-3705	9611-99-3705
9	1	Clamp		9613-0217-01	9613-0217-01	9613-0218-01	
10	1	Wing Nut		9612-5580-01	9612-5580-01	9612-5580-04	
11	1	Air Fitting		9611-99-1988	9611-99-1988	9611-99-1988	

Notes

Notes

Notes

Alfa Laval

9560 - 58th Place, Suite 300

Kenosha, WI 53144

USA

Tel: 262-605-2600

Fax: 262-605-2667



The information herein is correct at the time of issue, but may be subject to change without prior notice. © 2009 Alfa Laval Inc.



www.alfalaval.us